

GR-1100EX

(Left-hand drive)

110 Ton Capacity

SPEC. SHEET NO. GR-1100E-3-00104/R-04

HYDRAULIC ROUGH TERRAIN CRANE

DIMENSIONS

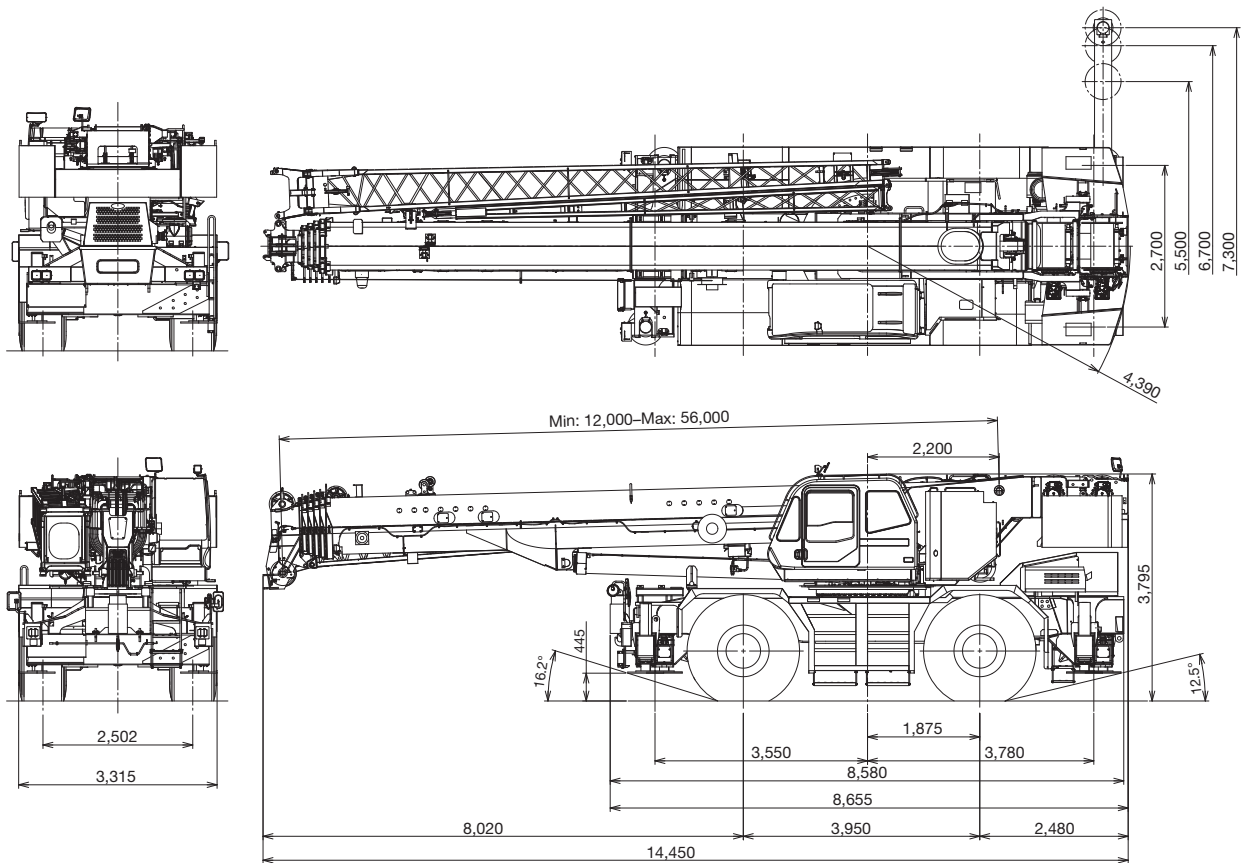

Note: Dimension is with boom angle at -1.5 degree.

GENERAL DIMENSIONS

Turning radius (29.5–25 34PR (OR))			
4 wheel steer	6.8 m	Overall length	approx. 14,450 mm
2 wheel steer	11.9 m	Overall width	approx. 3,315 mm
		Overall height	approx. 3,795 mm
		Carrier length for traveling	approx. 8,580 mm

CRANE SPECIFICATIONS

BOOM

6 sections boom of round box construction with 5 sheaves at boom head, extended by single telescoping cylinder.
2 easily removable wire rope guards, rope dead end provided on both sides of boom head. Boom telescope sections are supported by wear pads both vertically and horizontally.

Fully retracted length..... 12.0 m
Fully extended length..... 56.0 m
Extension speed..... 44 m in 340 s
Sheave root diameter..... 0.400 m

BOOM ELEVATION

By a double acting hydraulic cylinder with holding valve.
Boom angle indicator.

Automatic speed reduction and slow stop function.
Boom angle -1.5–81°
Boom raising speed 20° to 60° in 40 s

JIB

2 stage bi-fold lattice type, 3.5°, 25° or 45° offset.
Single sheave at the head of both jib sections. Stowed alongside base boom section. Assistant cylinders for mounting and stowing, controlled at right side of superstructure.
Self stowing jib mounting pins.

Length 10.1 m, 17.7 m
Offset..... 3.5°, 25°, 45°
Sheave root diameter..... 0.396 m

AUXILIARY LIFTING SHEAVE (SINGLE TOP)

Single sheave, mounted to main boom head for single line work (stowable).

Root diameter..... 0.440 m

ANTI-TWO BLOCK DEVICE

Pendant type over-winding cut out device with audio-visual (FAILURE lamp/BUZZER) warning system.

SLEWING

Hydraulic axial piston motor driven through planetary slewing speed reducer. Continuous full circle slewing on ball bearing turn table at 1.5 min⁻¹ {rpm}. Equipped with manually locked/released slewing brake. A 360° positive swing lock manually engaged in cab. Twin slewing system: Free slewing or lock slewing controlled by selector switch on front console.

Slewing speed..... 1.5 min⁻¹ {rpm}

COUNTERWEIGHT

Standard weight..... 10,000 kg

WINCH

MAIN WINCH

Variable speed type with grooved drum driven by hydraulic axial piston motor through speed reducer. Power load lowering and raising. Equipped with automatic brake (neutral brake) and counterbalance valve. Controlled independently of auxiliary winch. Equipped with cable follower and drum rotation indicator.

MAIN DRUM

Root diameter x wide 0.382 m x 0.742 m
Wire rope diameter x length 19 mm x 300 m
Drum capacity 394 m, 7 layers
Maximum single line pull (1st layer)..... 97.0 kN (9,900 kgf)
Maximum permissible linepull wire strength..... 70.6 kN (7,200 kgf)

AUXILIARY WINCH

Variable speed type with grooved drum driven by hydraulic axial piston motor through speed reducer.
Power load lowering and raising. Equipped with automatic brake (neutral brake) and counterbalance valve. Controlled independently of main winch. Equipped with cable follower and drum rotation indicator.

AUXILIARY DRUM

Root diameter x wide 0.382 m x 0.742 m
Wire rope diameter x length 19 mm x 158 m
Drum capacity 394 m, 7 layers
Maximum single line pull (1st layer)..... 97.0 kN (9,900 kgf)
Maximum permissible linepull wire strength..... 70.6 kN (7,200 kgf)

WIRE ROPE

Non-rotating 19 mm 7x35 class.
Breaking Strength 353.1 kN (36,000 kgf)

HOOK BLOCKS

110 ton (option) 8 sheaves with hook block and safety latch.
70 ton (option) 5 sheaves with hook block and safety latch.
45 ton (option) 3 sheaves with hook block and safety latch.
7.2 ton Weighted hook with swivel and safety latch.

HYDRAULIC SYSTEM

PUMPS

2 variable piston pumps for crane functions.
Tandem gear pump for steering, swing and optional equipment.
Powered by carrier engine. Pump disconnect for crane is engaged/ disengaged by rotary switch from operator's cab.

CONTROL VALVES

Multiple valves actuated by pilot pressure with integral pressure relief valves.

RESERVOIR

763 lit. capacity. External sight level gauge.

FILTRATION

BETA10=10 return filter, full flow with bypass protection, located inside of hydraulic reservoir. Accessible for easy replacement.

OIL COOLER

Air cooled fan type.

CAB AND CONTROLS

Both crane and drive operations can be performed from one cab mounted on rotating superstructure.

15° tilt, Left side, 1 man type, steel construction with sliding door access and safety glass windows opening at side. Door window is powered control. Windshield glass window and roof glass window are shatter-resistant. Tilt-telescoping steering wheel. Adjustable control lever stands for swing, boom elevating, boom telescoping, auxiliary winch and main winch. Control lever stands can change neutral positions and tilt for easy access to cab. 3 way adjustable operator's seat with high back, headrest and armrest. Engine throttle knob. Foot operated controls: boom elevating boom telescoping, service brake and engine throttle. Hot water cab heater and air conditioning.

Dash-mounted engine start/stop, monitor lamps, cigarette lighter, drive selector switch, parking brake switch, steering mode select switch, power window switch, pump engaged/ disengaged switch, swing brake switch, telescoping/auxiliary winch select switch, outrigger controls, free swing / lock swing selector switch, eco mode switch, high speed winch (main/aux) switch and ashtray.

Instruments - Torque converter oil temperature, engine water temperature, air pressure, fuel, speedometer, tachometer, hour meter and odometer / tripmeter. Hydraulic oil pressure is monitored and displayed on the AML-C display panel.

CRANE SPECIFICATIONS

TADANO Automatic Moment Limiter

(AML-C) including:

- Control lever lockout function with audible and visual pre-warning
- Boom position indicator
- Outrigger state indicator
- Boom angle / boom length / jib offset angle / jib length / load radius / rated lifting capacities / actual loads read out
- Ratio of actual load moment to rated load moment indication
- Automatic speed reduction and slow stop function on boom elevation and slewing
- Working condition register switch
- Load radius / boom angle / tip height / slewing range preset function
- External warning lamp
- Tare function
- Fuel consumption monitor
- Main winch / auxiliary winch select
- Drum rotation indicator (audible and visible type) main and auxiliary winch

TADANO AML-C monitors outrigger extended length and automatically programs the corresponding "RATED LIFTING CAPACITIES" table.

Operator's right hand console includes transmission gear selector and sight level bubble. Upper console includes working light switch, roof washer and wiper switch emergency outrigger set up key switch, jib equipped/removed select switch, eco mode switch, high speed winch (main / aux) switch, Cab tilt switch. Slewing lock lever.

NOTE: Each crane motion speed is based on unladen conditions.

CARRIER SPECIFICATIONS

TYPE

Rear engine, left hand steering, driving axle 2-way selected type by manual switch, 4x2 front drive, 4x4 front and rear drive.

FRAME

High tensile steel, all welded mono-box construction.

ENGINE

Model	MITSUBISHI 6M60-TLU3R [ECE-R96-02]
Type	Direct injection diesel
No. of cylinders	6
Combustion	4 cycle, turbo charged and after cooled
Bore x Stroke, mm	118 x 115
Displacement, liters	7.54
Air inlet heater	24 volt preheat
Air cleaner	Dry type, replaceable element
Oil filter	Full flow with replaceable element
Fuel filter	Full flow with replaceable element
Fuel tank, liters	300, right side of carrier
Cooling	Liquid pressurized, recirculating by-pass
Radiator	Fin and tube core, thermostat controlled
Fan, mm	Suction type, 6-blade, 600 dia.
Starting	24 volt
Charging	24 volt system, negative ground
Battery	2-120 amp. Hour
Compressor, air, l/min	830 at 2,600 min ⁻¹
Output, Max. kW (HP)	Gross 200 (267) at 2,600 min ⁻¹
Torque, Max. N·m	785 at 1,400 min ⁻¹
Capacity, liters	
Cooling water	13
Lubrication	13-15
Fuel	300

TRANSMISSION

Electronically controlled full automatic transmission. Torque converter driving full powershift with driving axle selector. 5 forward and 2 reverse speeds, constant mesh.

2 speeds - high range - 2 wheel drive; 4 wheel drive

3 speeds - low range - 4 wheel drive

TRAVEL SPEED

19 km/h

GRADEABILITY (tanθ) - 84% (at stall), 30%*

* Machine should be operated within the limit of engine crankcase design (17°: MITSUBISHI 6M60-TLU3R)

AXLE

Front: Full floating type, steering and driving axle with planetary reduction.

Rear: Full floating type, steering and driving axle with planetary reduction and non-spin rear differential.

STEERING

Hydraulic power steering controlled by steering wheel. Four steering modes available: 2 wheel front, 2 wheel rear, 4 wheel coordinated and 4 wheel crab.

SUSPENSION

Front: Rigid mounted to frame.

Rear: Pivot mounted with hydraulic lockout device.

BRAKE SYSTEMS

Service: Air over hydraulic disc brakes on all 4 wheels.

Parking/Emergency: Spring applied-air released brake acting on input shaft of front axle.

Auxiliary: Electro- pneumatic operated exhaust brake.

TIRES - 29.5-25 34PR (OR) Air pressure: 400 kPa

OUTRIGGERS

Four hydraulic, beam and jack outriggers. Vertical jack cylinders equipped with integral holding valve. Each outrigger beam and jack is controlled independently from cab. Beams extend to 7.3 m center-line and retract to within 3.315 m overall width with floats. Outrigger jack floats are attached thus eliminating the need of manually attaching and detaching them. Controls and sight bubble located in superstructure cab. Four outrigger extension lengths are provided with corresponding "RATED LIFTING CAPACITIES" for crane duty in confined areas.

Min. Extension 2.7 m center to center

Mid. Extension 5.5 m center to center

Mid. Extension 6.7 m center to center

Max. Extension 7.3 m center to center

Float size (Diameter) 0.6 m

STANDARD EQUIPMENT

- Telematics (machine data logging and monitoring system) with - HELLO-NET via internet (availability depends on countries)
- Eco mode system
- Positive control
- Over unwinding prevention
- Emergency steering system
- Transmission neutral position engine start
- Overshift prevention
- Parking braked travel warning
- Tilt-telescope steering wheel
- Halogen head lamp
- Fenders
- Air dryer
- Water separator with filter (high filtration)
- Air cleaner dust indicator
- Full instrumentation package
- Tire inflation kit
- Towing hooks-Front and rear
- Lifting eyes
- Hook block tie down (front bumper)
- Weighted hook storage compartment
- Winch drum mirror
- Beacon lamp
- Tool storage compartment

OPTIONAL EQUIPMENT

- Boom and jib mounted aircraft warning light
- Wind speed indicator
- 45 ton - 3 sheaves with hook block and safety latch
- 70 ton - 5 sheaves with hook block and safety latch
- 110 ton - 8 sheaves with hook block and safety latch
- Radiator cover
- Outrigger control box (Both side of carrier)
- Engine coolant heater
- Air heater

HOISTING PERFORMANCE

LINE SPEEDS AND PULLS

Layer	Main or auxiliary winch - 0.382 m drum		
	Line speeds ¹		Line pulls Available ²
	Low	High	Low
	m/min	m/min	kN (kgf)
1st	77	108	9,900
2nd	84	117	9,010
3rd	91	126	8,270
4th	97	136	7,640
5th	104	145	7,090
6th	110	154	6,620
7th ³	117	163	6,210

- Maximum permissible line pull wire strength. 70.6 kN (7,200 kgf) with 7 x 35 class rope.

- ¹ Line speed based only on hook block, not loaded.
² Developed by machinery with each layer of wire rope, but not based on rope strength or other limitations in machinery or equipment.
³ Seventh layer of wire rope are not recommended for hoisting operations.

DRUM WIRE ROPE CAPACITIES

Wire rope layer	Main and auxiliary drum grooved lagging	
	19 mm wire rope	
	Rope per layer	Total wire rope
	m	m
1	44.8	44.8
2	48.6	93.4
3	52.5	145.9
4	56.3	202.2
5	60.1	262.3
6	63.9	326.2
7	67.7	393.9

DRUM DIMENSIONS (Main and auxiliary)

Root diameter	382 mm
Length	742 mm
Flange diameter	677 mm

GR-1100EX WORKING RANGE CHART

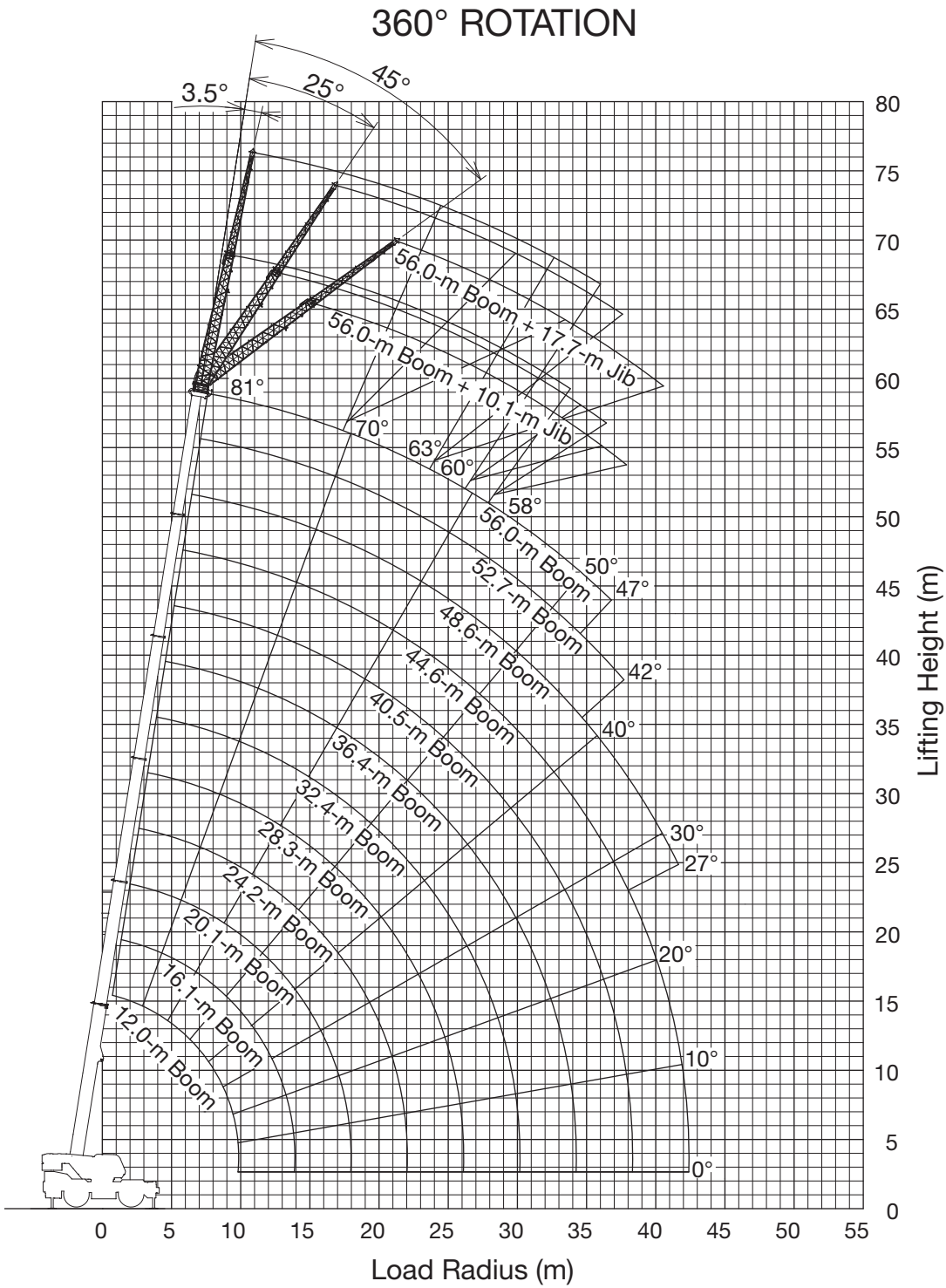

BOOM

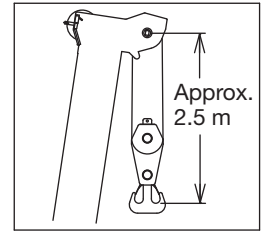

JIB

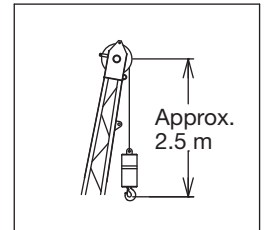

SINGLE TOP

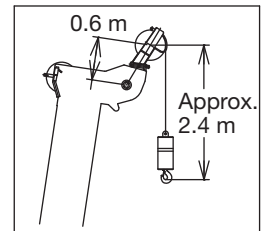

NOTE: Boom and jib geometry shown are for unloaded condition and machine standing level on firm supporting surface. Boom deflection and subsequent radius and boom angle change must be accounted for when applying load to hook.

GR-1100EX WORKING RANGE CHART

SMART CHART

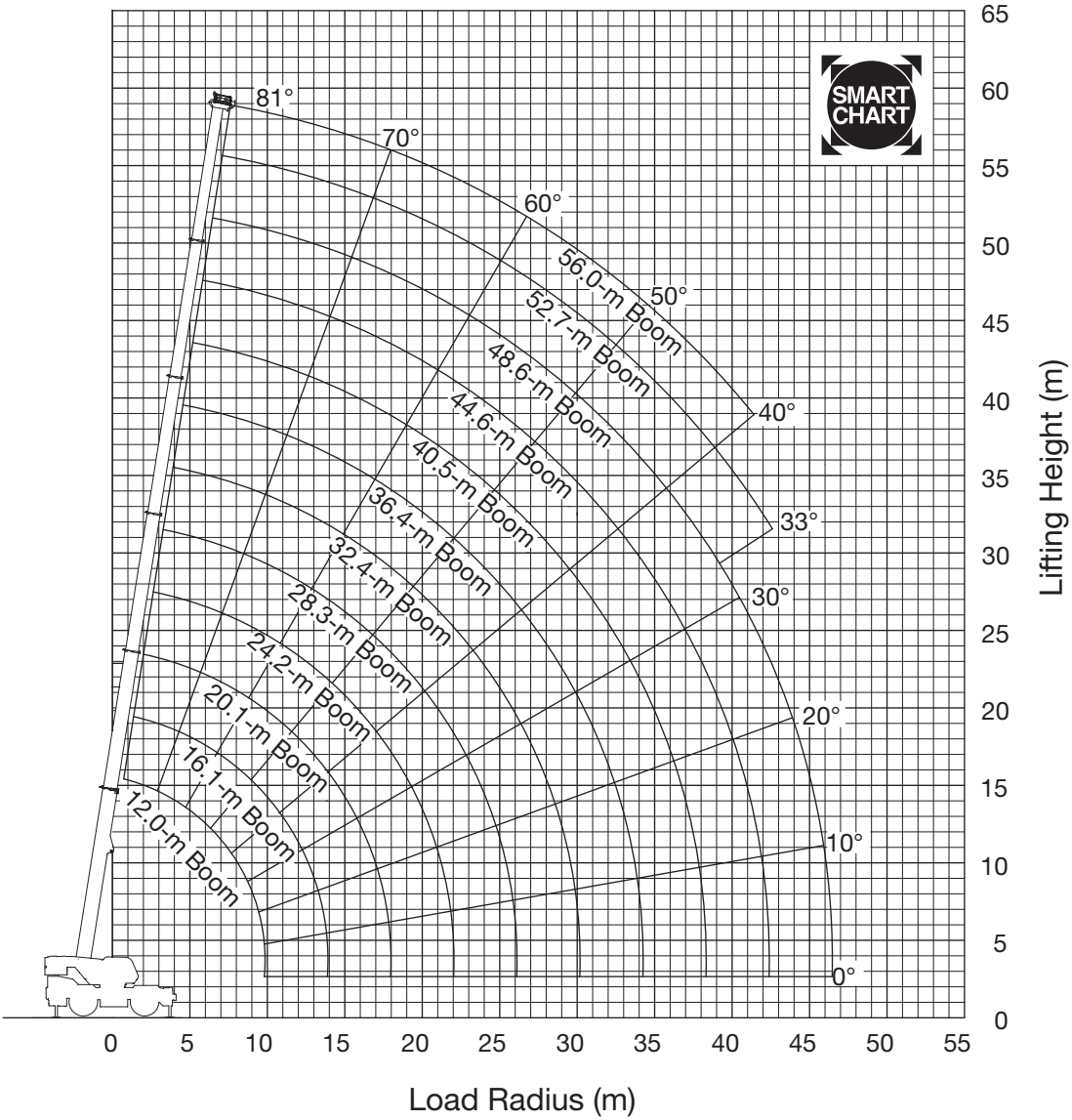

BOOM

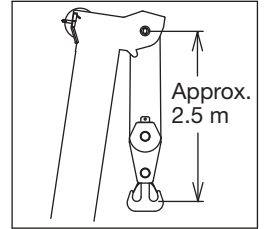

SINGLE TOP

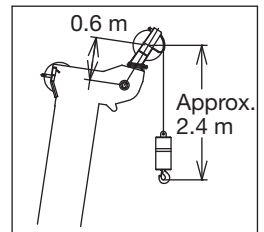

NOTE: Boom and jib geometry shown are for unloaded condition and machine standing level on firm supporting surface. Boom deflection and subsequent radius and boom angle change must be accounted for when applying load to hook.

GR-1100EX RATED LIFTING CAPACITIES (IN METRIC TON)

COUNTERWEIGHT 10.0 t ON OUTRIGGERS FULLY EXTENDED 7.3 m SPREAD 360° ROTATION													
C	56.0-m Boom + 10.1-m Manual offset jib						C	52.7-m Boom + 10.1-m Manual offset jib					
	3.5° Tilt		25° Tilt		45° Tilt			3.5° Tilt		25° Tilt		45° Tilt	
	R	W	R	W	R	W		R	W	R	W	R	W
81	13.9	4.5	17.4	3.9	20.5	3.6	81	13.3	5.0	16.8	4.3	19.4	3.8
80	15.3	4.5	18.5	3.8	21.6	3.5	80	14.5	5.0	17.8	4.2	20.4	3.8
79	16.6	4.4	19.8	3.7	22.7	3.4	79	15.6	4.9	18.8	4.1	21.4	3.7
78	18.0	4.3	20.9	3.6	23.7	3.3	78	16.9	4.8	19.9	4.0	22.4	3.6
77	19.1	4.1	22.1	3.5	24.9	3.2	77	17.6	4.6	21.0	3.9	23.4	3.5
76	20.4	4.0	23.3	3.5	26.1	3.2	76	19.1	4.5	22.1	3.8	24.4	3.4
75	21.7	3.9	24.5	3.4	27.1	3.1	75	20.2	4.4	23.1	3.7	25.4	3.4
73	24.1	3.7	26.8	3.2	29.3	3.0	73	22.4	4.1	25.2	3.5	27.4	3.3
70	27.7	3.3	30.1	3.0	32.5	2.9	70	25.6	3.8	28.5	3.3	30.4	3.1
68	29.6	2.7	31.9	2.5	34.3	2.4	68	27.7	3.4	30.5	3.1	32.3	2.9
65	32.3	2.0	34.7	1.9	36.6	1.8	65	30.4	2.6	33.1	2.3	34.7	2.3
63	34.0	1.6	36.4	1.5	38.3	1.5	63	32.2	2.1	35.0	1.9	36.2	1.9
60	36.6	1.1	38.9	1.1	40.6	1.0	60	35.0	1.6	37.1	1.4	38.4	1.4
58	38.2	0.8	40.4	0.8	42.2	0.8	58	36.5	1.2	38.7	1.2	39.9	1.2
55							55	38.8	0.8	41.0	0.8	42.0	0.8
53							53	40.4	0.6	42.4	0.6	43.4	0.6

COUNTERWEIGHT 10.0 t ON OUTRIGGERS FULLY EXTENDED 7.3 m SPREAD 360° ROTATION													
C	48.6-m Boom + 10.1-m Manual offset jib						C	32.4-m Boom + 10.1-m Manual offset jib					
	3.5° Tilt		25° Tilt		45° Tilt			3.5° Tilt		25° Tilt		45° Tilt	
	R	W	R	W	R	W		R	W	R	W	R	W
81	12.2	6.0	15.7	5.2	18.2	4.5	81	6.9	6.6	11.2	6.6	13.1	4.9
80	13.2	6.0	16.6	5.0	19.1	4.4	80	7.8	6.6	11.9	6.4	13.9	4.8
79	14.5	6.0	17.6	4.9	20.1	4.4	79	8.5	6.6	12.7	6.3	14.6	4.8
78	15.5	5.9	18.6	4.8	21.0	4.3	78	9.3	6.6	13.5	6.1	15.3	4.7
77	16.5	5.7	19.6	4.7	22.0	4.2	77	10.2	6.6	14.2	6.0	15.9	4.6
76	17.6	5.5	20.6	4.6	22.9	4.1	76	10.9	6.6	15.0	5.8	16.6	4.6
75	18.6	5.4	21.6	4.5	24.0	4.1	75	11.7	6.6	15.7	5.7	17.2	4.5
73	20.6	5.0	23.6	4.3	25.8	3.9	73	13.3	6.6	17.1	5.5	18.5	4.5
70	23.7	4.6	26.6	4.1	28.5	3.8	70	15.5	6.6	19.2	5.3	20.3	4.4
68	25.5	4.1	28.3	3.6	30.1	3.4	68	17.0	6.6	20.5	5.1	21.5	4.3
65	28.1	3.1	30.7	2.8	32.3	2.6	65	19.1	6.6	22.4	4.9	23.2	4.2
63	29.8	2.6	32.3	2.3	33.7	2.2	63	20.4	6.6	23.6	4.8	24.4	4.2
60	32.2	1.9	34.6	1.8	35.7	1.7	60	22.3	6.2	25.4	4.7	26.0	4.2
58	33.9	1.6	36.0	1.5	37.1	1.4	58	23.5	5.8	26.6	4.7	27.1	4.2
55	36.0	1.1	38.1	1.1	39.2	1.1	55	25.3	5.0	28.2	4.4	28.6	4.1
53	37.5	0.9	39.5	0.8	40.4	0.8	53	26.4	4.5	29.2	4.0	29.5	3.8
50	39.6	0.6					50	28.0	3.9	30.6	3.5	30.8	3.4
48							48	29.0	3.5	31.5	3.2	31.6	3.1
45							45	30.5	3.1	32.8	2.9	32.8	2.8
43							43	31.4	2.8	33.6	2.6		
40							40	32.8	2.5	34.7	2.3		
38							38	33.6	2.3	35.4	2.2		
35							35	34.9	2.1	36.4	2.0		
33							33	35.6	1.9	37.0	1.8		
30							30	36.6	1.7	37.8	1.7		
25							25	38.2	1.5	38.9	1.4		
20							20	39.4	1.3				
15							15	40.3	1.1				
10							10	40.8	1.1				

C: Loaded boom angle (°)
R: Load radius (m)
W: Rated lifting capacity (Unit: x 1,000 kg)

GR-1100EX RATED LIFTING CAPACITIES (IN METRIC TON)

COUNTERWEIGHT 10.0 t ON OUTRIGGERS FULLY EXTENDED 7.3 m SPREAD 360° ROTATION													
C	56.0-m Boom + 17.7-m Manual offset jib						C	52.7-m Boom + 17.7-m Manual offset jib					
	3.5° Tilt		25° Tilt		45° Tilt			3.5° Tilt		25° Tilt		45° Tilt	
	R	W	R	W	R	W		R	W	R	W	R	W
81	16.2	2.9	23.0	2.7	27.4	2.3	81	15.2	3.1	21.3	2.8	26.3	2.3
80	17.7	2.9	24.3	2.6	28.6	2.2	80	16.5	3.1	22.9	2.8	27.3	2.3
79	19.3	2.9	25.6	2.5	29.9	2.2	79	18.0	3.1	24.0	2.7	28.4	2.3
78	20.8	2.9	27.1	2.5	31.1	2.2	78	19.4	3.1	25.2	2.6	29.5	2.2
77	22.4	2.9	28.3	2.4	32.3	2.1	77	20.8	3.1	26.5	2.6	30.6	2.2
76	24.0	2.9	29.7	2.4	33.4	2.1	76	22.1	3.1	27.7	2.5	31.7	2.2
75	25.4	2.8	30.9	2.3	34.7	2.1	75	23.5	3.1	28.9	2.5	32.7	2.1
73	28.4	2.7	33.5	2.2	36.9	2.0	73	26.2	3.0	31.3	2.4	34.8	2.1
70	32.1	2.3	37.0	1.9	39.9	1.8	70	30.2	2.8	34.8	2.3	37.8	2.0
68	34.0	1.8	38.8	1.5	41.6	1.4	68	32.3	2.4	36.8	2.0	39.6	1.8
65	36.7	1.2	41.6	1.1	44.2	1.0	65	35.4	1.8	39.6	1.5	42.1	1.3
63	38.7	0.9	43.4	0.8	45.9	0.8	63	37.1	1.4	41.3	1.2	43.6	1.1
60							60	39.8	1.0	43.7	0.8	45.8	0.7
58							58	41.5	0.7	45.4	0.6		

COUNTERWEIGHT 10.0 t ON OUTRIGGERS FULLY EXTENDED 7.3 m SPREAD 360° ROTATION													
C	48.6-m Boom + 17.7-m Manual offset jib						C	32.4-m Boom + 17.7-m Manual offset jib					
	3.5° Tilt		25° Tilt		45° Tilt			3.5° Tilt		25° Tilt		45° Tilt	
	R	W	R	W	R	W		R	W	R	W	R	W
81	14.1	3.5	20.2	3.0	24.6	2.4	81	9.2	4.5	15.8	3.3	19.7	2.4
80	15.3	3.5	21.4	3.0	25.6	2.3	80	10.2	4.5	16.7	3.2	20.5	2.3
79	16.7	3.5	22.5	2.9	26.7	2.3	79	11.1	4.5	17.5	3.1	21.2	2.3
78	18.0	3.5	23.6	2.8	27.7	2.3	78	12.1	4.5	18.3	3.0	22.0	2.3
77	19.2	3.5	24.8	2.8	28.7	2.2	77	13.1	4.5	19.1	3.0	22.7	2.2
76	20.5	3.5	25.9	2.7	29.7	2.2	76	14.0	4.5	20.0	2.9	23.4	2.2
75	21.9	3.5	27.1	2.7	30.7	2.2	75	14.9	4.5	20.8	2.9	24.1	2.2
73	24.4	3.5	29.3	2.6	32.7	2.2	73	16.7	4.5	22.4	2.8	25.5	2.2
70	28.0	3.3	32.5	2.4	35.5	2.1	70	19.2	4.1	24.6	2.6	27.4	2.1
68	30.2	3.0	34.6	2.3	37.5	2.1	68	20.8	3.8	26.2	2.5	28.7	2.1
65	32.9	2.2	37.5	1.9	39.8	1.6	65	23.2	3.6	28.3	2.4	30.5	2.0
63	34.8	1.8	39.0	1.5	41.3	1.4	63	24.7	3.4	29.7	2.4	31.7	2.0
60	37.2	1.3	41.3	1.1	43.4	1.0	60	27.0	3.2	31.7	2.3	33.5	2.0
58	38.9	1.0	42.9	0.9	44.8	0.8	58	28.5	3.2	33.0	2.3	34.5	2.0
55	41.3	0.6					55	30.6	3.0	34.8	2.2	36.1	2.0
53							53	31.9	2.9	36.0	2.2	37.0	1.9
50							50	33.8	2.8	37.7	2.1	38.3	1.9
48							48	35.0	2.5	38.7	2.1	39.1	1.9
45							45	36.7	2.2	40.1	1.9	40.3	1.8
43							43	37.8	2.0	41.0	1.7		
40							40	39.3	1.7	42.2	1.5		
38							38	40.3	1.6	42.9	1.4		
35							35	41.7	1.4	43.9	1.2		
33							33	42.5	1.2	44.5	1.1		
30							30	43.7	1.1	45.3	1.0		
25							25	45.4	0.9	46.4	0.8		
20							20	46.8	0.8				
15							15	47.8	0.7				
10							10	48.3	0.6				

C: Loaded boom angle (°)
R: Load radius (m)
W: Rated lifting capacity (Unit: x 1,000 kg)

GR-1100EX RATED LIFTING CAPACITIES (IN METRIC TON) ISO 4305

COUNTERWEIGHT 10.0 t ON-RUBBER STATIONARY (Unit: x 1,000 kg)																			
A	Over front										360° Rotation								
	12.0 m		16.1 m		20.1 m		24.2 m		28.3 m		12.0 m		16.1 m		20.1 m	24.2m	28.3m		
B	C		C		C		C		C		C	C		C	C	C			
4.5	63	23.2																	
5.0	60	21.0																	
6.0	54	17.5	65	18.6															
7.0	47	14.8	60	15.8															
8.0	39	12.6	56	13.7	64	14.2													
9.0	29	10.8	51	11.9	61	12.4	67	12.9	71	12.9									
10.0			46	10.4	57	10.9	64	11.4	69	11.5									
11.0			40	9.2	54	9.7	61	10.2	67	10.3									
12.0			34	7.0	50	7.6	58	9.1	64	9.2									
14.0					41	5.6	52	6.2	59	6.3									
16.0					30	4.2	46	4.8	54	4.9									
18.0							38	3.7	49	3.8									
20.0							28	2.9	43	3.0									
22.0							12	2.3	36	2.3									
24.0									27	1.8									
26.0									12	1.4									
D	0										0	0	27	37	48				
Telescoping conditions (%)																			
Tele.1	0	0	0	0	0	0	0	0	0	0	0	0	0	0	0	0	0	0	
Tele.2	0	0	0	0	0	0	0	0	0	0	0	0	0	0	0	0	0	0	
Tele.3	0	0	0	0	0	0	0	0	0	0	0	0	0	0	0	0	0	0	
Tele.4	0	0	0	0	0	46	92	92	92	92	0	0	46	92	92	92	92	92	
Tele.5	0	46	92	92	92	92	92	92	92	92	0	46	92	92	92	92	92	92	
E	4										4								

- A: Boom length (m)
- B: Load radius (m)
- C: Loaded boom angle (°)
- D: Minimum boom angle (°) for indicated length (no load)
- E: Number of parts of line

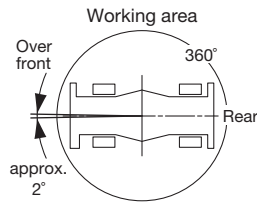

NOTE: The lifting capacity data stored in the AUTOMATIC MOMENT LIMITER (AML-C) is based on the standard number of parts of line listed in the chart. Standard number of parts of line for on-rubber operation should be according to the chart.

COUNTERWEIGHT 10.0 t ON-RUBBER CREEP (Unit: x 1,000 kg)											
A	Over front										
	12.0 m		16.1 m		20.1 m		24.2 m		28.3 m		
B	C		C		C		C		C		
4.5	63	17.1									
5.0	60	15.3									
6.0	54	12.5	65	13.6							
7.0	47	10.3	60	11.4							
8.0	39	8.6	56	9.7	64	10.2					
9.0	29	7.2	51	8.3	61	8.8	67	9.3	71	9.4	
10.0			46	7.1	57	7.7	64	8.2	69	8.3	
11.0			40	6.1	54	6.7	61	7.2	67	7.3	
12.0			34	5.3	50	5.8	58	6.4	64	6.4	
14.0					41	4.5	52	5.0	59	5.1	
16.0					30	3.4	46	3.9	54	4.0	
18.0							38	3.1	49	3.2	
20.0							28	2.4	43	2.5	
22.0							12	1.9	36	1.9	
24.0									27	1.5	
26.0									12	1.1	
D	0										
Telescoping conditions (%)											
Tele.1	0	0	0	0	0	0	0	0	0	0	
Tele.2	0	0	0	0	0	0	0	0	0	0	
Tele.3	0	0	0	0	0	0	0	0	0	0	
Tele.4	0	0	0	0	0	46	92	92	92	92	
Tele.5	0	46	92	92	92	92	92	92	92	92	
E	4										

- A: Boom length (m)
- B: Load radius (m)
- C: Loaded boom angle (°)
- D: Minimum boom angle (°) for indicated length (no load)
- E: Number of parts of line

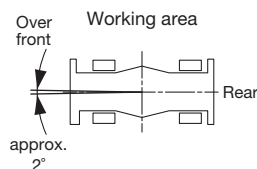

NOTE: The lifting capacity data stored in the AUTOMATIC MOMENT LIMITER (AML-C) is based on the standard number of parts of line listed in the chart. Standard number of parts of line for on-rubber operation should be according to the chart.

WARNING AND OPERATING INSTRUCTIONS FOR ON RUBBER LIFTING CAPACITIES

NOTES FOR ON-RUBBER LIFTING CAPACITIES

- Rated lifting capacities on rubber based on crane stability are according to ISO 4305.
- Rated lifting capacities shown in the chart are based on condition that crane is set on firm level surfaces with suspension-lock applied. Those above thick lines are based on tire capacity and those below, on crane stability. They are based on actual load radius increased by tire deformation and boom deflection.
- If the suspension-lock cylinders contain air, the axle will not be locked completely and rated lifting capacities may not be obtainable. Bleed the cylinders according to the operation safety and maintenance manual.
- Rated lifting capacities are based on proper tire inflation, capacity and condition. Damaged tires are hazardous to safe operation of crane.
- Tires shall be inflated to correct air pressure.
- Over front operation shall be performed within 2 degrees in front of chassis. When boom is out of 2 degrees in front of chassis, 360° capacities are effective.
- On rubber lifting with "jib" is not permitted. Maximum permissible boom length is 28.3 m.
- When making lift on rubber stationary, set parking brake.
- When a load is lifted in the front position and then swung to the side area, make sure that the value of the AML is below 360° lifting capacity.
- Do not operate the crane while carrying the load.
- Creep is motion for crane not to travel more than 60 m in any 30 minute period and to travel at the speed of less than 1.6 km/h.
- For creep operation, choose the drive mode and proper gear according to the road or working condition.
- The mass of the hook (1,080 kg for 110 t capacity, 680 kg for 70 t capacity, 610 kg for 45 t capacity, 300 kg for 7.2 t capacity), slings and all similarly used load handling devices must be considered as part of the load and must be deducted from the lifting capacities.
- For rated lifting capacity of single top, reduce the rated lifting capacities of relevant boom according to a weight reductions for auxiliary load handling equipment. Capacities of single top shall not exceed 7,200 kg including main hook.
- The lifting capacity data stored in the Automatic Moment Limiter (AML-C) is based on the standard number of parts of line listed in the chart. Standard number of parts of line for on rubber operation should be according to the following table.

Tires	Air Pressure
29.5-25 34PR	400 kPa

Boom length	12.0 m to 28.3 m	Single top jib
Number of parts of line	4	1

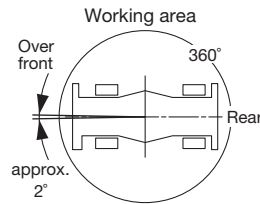

WARNING AND OPERATING INSTRUCTIONS

NOTES FOR LIFTING CAPACITIES

GENERAL

1. RATED LIFTING CAPACITIES apply only to the machine as originally manufactured and normally equipped by TADANO LTD. Modifications to the machine or use of optional equipment other than that specified can result in a reduction of capacity.
2. Hydraulic cranes can be hazardous if improperly operated or maintained. Operation and maintenance of this machine must be in compliance with information, in the Operation and Maintenance Manual supplied with the crane. If this manual is missing, order a replacement through the distributor.

SET UP

1. Rated lifting capacities on the chart are the maximum allowable crane capacities and are based on the machine standing level on firm supporting surface under ideal job conditions. Depending on the nature of the supporting surface, it may be necessary to have structural supports under the outrigger floats or tires to spread the loads to a larger bearing surface.
2. For outrigger operation, outriggers shall be properly extended with tires free of supporting surface before operating crane.

OPERATION

1. Rated lifting capacities based on crane stability are according to ISO 4305.
2. Rated lifting capacities above thick lines in the chart are based on crane strength and those below, on its stability. They are based on actual load radius increased by boom deflection.
3. The weight of handling device such as hook blocks (1,080 kg for 110 t capacity, 680 kg for 70 t capacity, 610 kg for 45 t capacity, 300 kg for 7.2 t capacity), slings, etc., must be considered as part of the load and must be deducted from the lifting capacities.
4. Rated lifting capacities are based on freely suspended loads and make no allowance for such factors as the effect of wind, sudden stopping of loads, supporting surface conditions, inflation of tires, operating speeds, side loads, etc. Side pull on the boom or jib is extremely dangerous. Such action can damage the boom, jib or swing mechanism, and lead to overturning of the crane.
5. Rated lifting capacities do not account for wind on lifted load or boom. We recommend against working under the condition that the load is out of control due to a strong wind. During boom lift, consider that the rated lifting capacity is reduced by 50% when the wind speed is 9 m/s to 12 m/s; reduced by 70% when the wind speed is 12 m/s to 14 m/s. If the wind speed is 14 m/s or over, stop operation.
However, in the following conditions, stop operation at wind speed of 12 m/s: Boom length is 56 m (all 100%), and boom angle is 55° or less. Boom length is 52.7 m (all 92%), and boom angle is 45° or less.
During jib lift, stop operation if the wind speed is 9 m/s or over.
6. Rated lifting capacities at load radius shall not be exceeded. Do not tip the crane to determine allowable loads.
7. Do not operate at boom lengths, radii, or boom angle, where no capacities are shown. Crane may overturn without any load on the hook.
8. When boom length is between values listed, refer to the rated lifting capacities of the next longer and next shorter booms for the same radius. The lesser of the two rated lifting capacities shall be used.
9. When making lifts at a load radius not shown, use the next longer radius to determine allowable capacity.
10. Load per line should not exceed 7,200 kg for main winch and auxiliary winch.
11. Check the actual number of parts of line with AUTOMATIC MOMENT LIMITOR (AML-C) before operation.
Maximum lifting capacity is restricted by the number of parts of line of AUTOMATIC MOMENT LIMITOR (AML-C).
Limited capacity is as determined from the formula, Single line pull for main winch $7,200 \text{ kg} \times \text{number of parts of line}$.

12. The boom angle before loading should be greater to account for deflection. For rated lifting capacities, the loaded boom angle and the load radius is for reference only.
13. Maximum capacity without boom pin is shown in the chart.
14. Do not operate extension or retraction of the boom with loads.
15. For lifting capacity of single top, deduct the weight of the load handling equipment from the rated lifting capacity of the boom. For the lifting capacity of single top, the net capacity shall not exceed 7,200 kg including main boom hook mass attached to the boom.
16. When the base jib or top jib or both jibs are removed, set the jib status switch to the DISMOUNTED position.
17. When erecting and stowing jib, be sure to retain it by hand or by other means to prevent its free movement.
18. Use "ANTI-TWO-BLOCK" disable switch when erecting and stowing jib and when stowing hook block. While the switch is pushed, the hoist does not stop, even when overwind condition occurs.
19. For selected boom length or less with jib, rated lifting capacities are determined by loaded boom angle only in the column headed "selected boom + jib".
20. Outriggers shall be extended 7.3 m spread when installing or removing removable counterweight.
21. The boom extending operation and lowering operation are prohibited during lifting a load with multiple line lift. When lifting a load by using jib (aux. winch) and boom (main winch) simultaneously, do the following:
 - Enter the operation status as jib operation, not as boom operation.
 - Before starting operation, make sure that the mass of a load is within the rated lifting capacity for the jib. (The AML display indicates inaccurate working radius and actual load values during multiple line lift.)
 When lifting a load by using single top (aux. winch) and boom (main winch) simultaneously, do the following:
 - Enter the operation status as single top operation, not as boom operation.
 - Before starting operation, make sure that the mass of a load is within the rated lifting capacity for the single top. (The AML display indicates inaccurate working radius and actual load values during multiple line lift.)
22. Traveling on road in a special steering mode (four-wheel steering, four-wheel sideways steering, etc.) is very dangerous, and must be strictly avoided. Drive the machine in two-wheel steering mode only.
Special steering modes should only be used for low speed travel within work sites.

DEFINITIONS

1. Load Radius: Horizontal distance from a projection of the axis of rotation to supporting surface before loading to the center of the vertical hoist line or tackle with load applied.
2. Loaded Boom Angle: The angle between the boom base section and the horizontal, after lifting the rated lifting capacity at the load radius.
3. Working Area: Area measured in a circular arc about the centerline of rotation.
4. Freely Suspended Load: Load hanging free with no direct external force applied except by the hoist line.
5. Side Load: Horizontal side force applied to the lifted load either on the ground or in the air.

NOTES FOR LOAD MOMENT INDICATOR (AML-C)

- Set AML select keys in accordance with the actually operating crane conditions and don't fail to make sure, before crane operation, that the displays on front panel are correct.
- When operating crane on outriggers:
 - Set "P.T.O." SWITCH to "ON".
 - Press the outrigger state select key to register for the outrigger operation. If the display agrees with the actual state, press the set key to register. After the completion of the registration, the pop-up window closes.
 - Press the lift state select key to register the lift state to be used (single top/jib/boom).
 - Each time the lift state select key is pressed, the display changes. If the display agrees with the actual state, press the set key to register. After the completion of the registration, the pop-up window closes.
 - When erecting and stowing jib, select the status of jib set (Jib state indicative symbol flicker).
- When operating crane on rubber:
 - Set "P.T.O." switch to "ON".
 - Press the outrigger state select key to register for the on-rubber operation. Each time the outrigger state select key is pressed, the display changes. Select the creep operation, the on-rubber state indicator symbol flickers.
 - Press the lift state and creep select key to register the lift state. However, pay attention to the following.
 - For stationary operation.
 - The front capacities are attainable only when the over front position symbol comes on. When the boom is more than 2 degrees from centered over front of chassis, 360° capacities are in effect.
 - When a load is lifted in the front position and then swung to the side area, make sure the value of the AUTOMATIC MOMENT LIMITER (AML-C) is below the 360° lifting capacity.
 - For creep operation.
 - The creep capacities are attainable only when boom is in the straight forward position of chassis and the over front position symbol is on. If boom is not in the straight forward position of chassis, never lift load.
- This machine is equipped with an automatic swing stopping device. (For the details, see Operation and Maintenance Manual.) But, operate very carefully because the automatic swing stop does not work in the following cases.
 - During on-rubber operation.
- During crane operation, make sure that the displays on front panel are in accordance with actual operating conditions.
- The displayed values of AUTOMATIC MOMENT LIMITER (AML-C) are based on freely suspended loads and make no allowance for such factors as the effect of wind, sudden stopping of loads, supporting surface conditions, inflation of tire, operating speed, side loads, etc. For safe operation, it is recommended when extending and lowering boom or swinging, lifting loads shall be appropriately reduced.
- AUTOMATIC MOMENT LIMITER (AML-C) is intended as an aid to the operator. Under no condition should it be relied upon to replace use of capacity charts and operating instruction. Sole reliance upon AUTOMATIC MOMENT LIMITER (AML-C) aids in place of good operating practice can cause an accident. The operator must exercise caution to assure safety.
- The lifting capacity differs depending on the outrigger extension width and slewing position. Work with the capacity corresponding to the outrigger extension width and slewing position. For the relationship among the outrigger extension width, slewing position and lifting capacities, refer to the working area charts.

GR-1100EX Axle weight distribution chart

	Kilograms		
	GVW	Front	Rear
Basic machine	55,590	27,740	27,850
Remove:			
1. 7.2 ton hook block	-300	-457	157
2. 110 ton hook block	-1,080	-2,085	1,005
3. Top jib	-334	-448	114
4. Base jib	-857	-1,697	840
5. Auxiliary lifting sheave	-59	-175	116
6. Counterweight	-10,000	4,367	-14,367
7. Auxiliary winch & wire rope	-1,031	464	-1,494
Add:			
1. 70 ton hook block	680	1,313	-633
2. 45 ton hook block	610	1,178	-568



TADANO

TADANO LTD. (International Sales Division)

KANDA SQUARE 18th Floor,
2-2-1 Kanda-Nishikicho,
Chiyoda-ku, Tokyo 101-0054, Japan

Phone : +81-3-6811-7309

[URL](http://www.tadano.com) www.tadano.com

[E-mail](mailto:info@tadano.com) info@tadano.com

Printed in Japan
2022-11-1