

# GR-1450EX

(Left-hand drive)  
145 Ton Capacity

SPEC. SHEET NO. GR-1450E-3-00104/R-03

## HYDRAULIC ROUGH TERRAIN CRANE

### DIMENSIONS

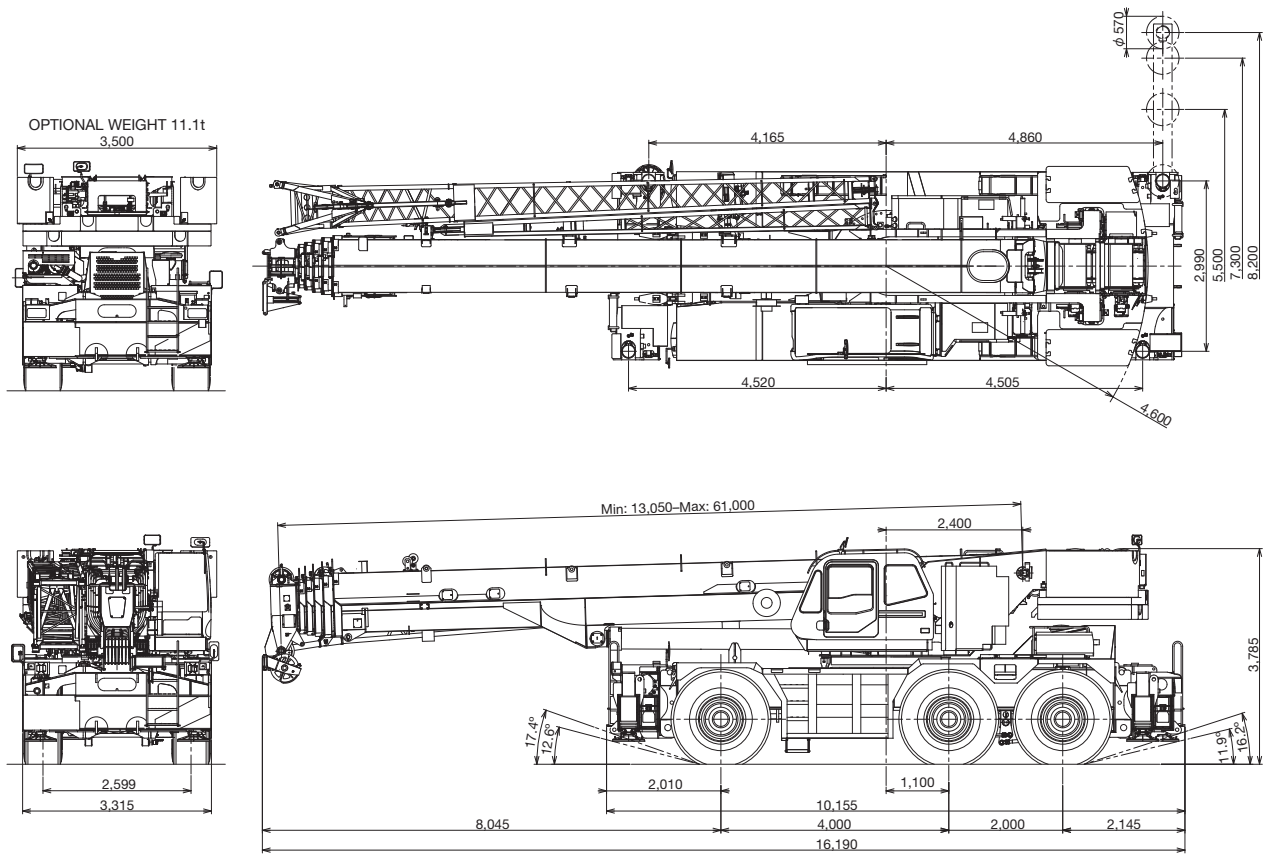

Note : Dimension is with boom angle at -1.5 degree.

### GENERAL DIMENSIONS

Turning radius (26.5R25☆☆ Tires)	6 wheel steer	9.9 m	Overall length	approx. 16,190 mm
	2 wheel steer	14.9 m		Overall width
			Overall height	approx. 3,785 mm
			Carrier length for traveling	approx. 8,260 mm

# CRANE SPECIFICATIONS

## BOOM

6 sections boom of round box construction with 7 sheaves at boom head, extended by single telescoping cylinder.  
2 easily removable wire rope guards, rope dead end provided on both sides of boom head. Boom telescope sections are supported by wear pads both vertically and horizontally.

Fully retracted length.....	13.1 m
Fully extended length.....	61.0 m
Extension speed.....	47.9 m in 450 s
Sheave root diameter.....	0.400 m

## BOOM ELEVATION

By a double acting hydraulic cylinder with holding valve.  
Boom angle indicator.

Automatic speed reduction and slow stop function.

Boom angle.....	-1.5–81.5°
Boom raising speed.....	20° to 60° in 28 s

## JIB

2 stage bi-fold lattice type, 0°, 20° or 40° offset.  
Single sheave at the head of both jib sections. Stowed alongside base boom section. Assistant cylinders for mounting and stowing, controlled at right side of superstructure.  
Self stowing jib mounting pins.

Length.....	10.3 m, 18.0 m
Offset.....	0°, 20°, 40°
Sheave root diameter.....	0.440 m

## INSERT JIB (OPTION)

Insert lattice jib can be used for reaching higher place.

Length.....	7.0 m (1 pce.), 14.0 m (2 pcs.)
-------------	---------------------------------

## SHORT JIB (OPTION)

2 sheaves, heavy lifting jib can be used for lifting heavy load in tight spaces.

Length.....	3.6 m
Offset.....	20°, 40°
Sheave root diameter.....	0.419 m

## AUXILIARY LIFTING SHEAVE (SINGLE TOP)

Single sheave, mounted to main boom head for single line work (stowable).

Root diameter.....	0.440 m
--------------------	---------

## ANTI-TWO BLOCK DEVICE

Pendant type over-winding cut out device with audio-visual (FAILURE lamp/BUZZER) warning system.

## SLEWING

Hydraulic axial piston motor driven through planetary slewing speed reducer. Continuous 360° full circle slewing on ball bearing turn table at 1.3min<sup>-1</sup>{rpm}. Equipped with manually locked/released slewing brake. A 360° positive swing lock manually engaged in cab. Twin slewing system: Free slewing or lock slewing controlled by selector switch in cab.

Slewing speed.....	1.3 min <sup>-1</sup> {rpm}
--------------------	-----------------------------

## COUNTERWEIGHT

Standard weight.....	18,200 kg
Extra weight right.....	5,550 kg
Extra weight left.....	5,550 kg

## WINCH

### MAIN WINCH

Variable speed type with grooved drum driven by hydraulic axial piston motor through speed reducer. Power load lowering and raising. Equipped with automatic brake (neutral brake) and counterbalance valve. Controlled independently of auxiliary winch. Equipped with cable follower and drum rotation indicator.

### MAIN DRUM

Root diameter x wide.....	0.382 m x 0.742 m
Wire rope diameter x length.....	19 mm x 320 m
Drum capacity.....	394 m, 7 layers
Maximum single line pull (1st layer).....	97.0 kN (9,900 kgf)
Maximum permissible linepull wire strength.....	70.6 kN (7,200 kgf)

## AUXILIARY WINCH

Variable speed type with grooved drum driven by hydraulic axial piston motor through speed reducer.  
Power load lowering and raising. Equipped with automatic brake (neutral brake) and counterbalance valve. Controlled independently of main winch. Equipped with cable follower and drum rotation indicator.

## AUXILIARY DRUM

Root diameter x wide.....	0.382 m x 0.742 m
Wire rope diameter x length.....	19 mm x 225 m
Drum capacity.....	394 m, 7 layers
Maximum single line pull (1st layer).....	97.1 kN (9,900 kgf)
Maximum permissible linepull wire strength.....	70.6 kN (7,200 kgf)

## WIRE ROPE

Non-rotating.....	19 mm 7 x 35 class.
Breaking Strength.....	353.1 kN (36,000 kgf)

## HOOK BLOCKS

7.2 ton.....	Weighted hook with swivel and safety latch.
--------------	---

## HYDRAULIC SYSTEM

### PUMPS

2 variable piston pumps for crane functions.  
Tandem gear pump for steering, slewing and optional equipment. Powered by carrier engine. Pump disconnect for crane is engaged/ disengaged by rotary switch from operator's cab.

### CONTROL VALVES

Multiple valves actuated by pilot pressure with integral pressure relief valves.

### RESERVOIR

763 lit. capacity. External sight level gauge.

### FILTRATION

BETA10=10 return filter, full flow with bypass protection, located inside of hydraulic reservoir. Accessible for easy replacement.

### OIL COOLER

Air cooled fan type.

## CAB AND CONTROLS

Both crane and drive operations can be performed from one cab mounted on rotating superstructure.

15° tilt, Left side, 1 man type, steel construction with sliding door access and safety glass windows opening at side. Door window is powered control. Windshield glass window and roof glass window are shatter-resistant. Tilt-telescoping steering wheel. Adjustable control lever stands for swing, boom elevating, boom telescoping, auxiliary winch and main winch. Control lever stands can change neutral positions and tilt for easy access to cab. 3 way adjustable operator's seat with high back, headrest and armrest. Engine throttle knob. Foot operated controls: boom elevating boom telescoping, service brake and engine throttle. Hot water cab heater and air conditioning.

Dash-mounted engine start/stop, monitor lamps, cigarette lighter, drive selector switch, parking brake switch, steering mode select switch, power window switch, pump engaged/ disengaged switch, swing brake switch, telescoping/auxiliary winch select switch, outrigger controls, free swing / lock swing selector switch, eco mode switch, high speed winch (main/aux) switch and ashtray.

Instruments - Torque converter oil temperature, engine water temperature, air pressure, fuel, speedometer, tachometer, hour meter and odometer / tripmeter. Hydraulic oil pressure is monitored and displayed on the AML-C display panel.

# CRANE SPECIFICATIONS

TADANO Automatic Moment Limiter

(AML-C) including:

- Control lever lockout function with audible and visual pre-warning
- Boom position indicator
- Outrigger state indicator
- Boom angle / boom length / jib offset angle / jib length / load radius / rated lifting capacities / actual loads read out
- Ratio of actual load moment to rated load moment indication
- Automatic speed reduction and slow stop function on boom elevation and slewing
- Working condition register switch
- Load radius / boom angle / tip height / slewing range preset function
- External warning lamp
- Tare function
- Fuel consumption monitor
- Main winch / auxiliary winch select
- Drum rotation indicator (audible and visible type) main and auxiliary winch

TADANO AML-C monitors outrigger extended length and automatically programs the corresponding "RATED LIFTING CAPACITIES" table.

Operator's right hand console includes transmission gear selector and sight level bubble. Upper console includes working light switch, roof washer and wiper switch emergency outrigger set up key switch, jib equipped/removed select switch, eco mode switch, high speed winch (main / aux) switch and Cab tilt switch. Slewing lock lever.

NOTE: Each crane motion speed is based on unladen conditions.

# CARRIER SPECIFICATIONS

## TYPE

Rear engine, left hand steering, driving axle 2-way selected type by manual switch, 6x2 1st drive, 6x4 1st and 3rd drive.

## FRAME

High tensile steel, all welded mono-box construction.

## ENGINE

Model	MITSUBISHI 6M60-TL
Type	Direct injection diesel
No. of cylinders	6
Combustion	4 cycle, turbo charged and after cooled
Bore x Stroke, mm. (in)	118 x 115 (4.646 x 4.528)
Displacement, liters (cu. in)	7.54 (460)
Air inlet heater	24 volt preheat
Air cleaner	Dry type, replaceable element
Oil filter	Full flow with replaceable element
Fuel filter	Full flow with replaceable element
Fuel tank, liters (gal.)	300 (79.2), right side of carrier
Cooling	Liquid pressurized, recirculating by-pass
Radiator	Fin and tube core, thermostat controlled
Fan, mm (in.)	Suction type, 6-blade, 600 (23.6) dia.
Starting	24 volt
Charging	24 volt system, negative ground
Battery	2-120 amp. Hour
Compressor, air, l / min (CFM)	830 (29) at 2,600 rpm
Output, Max. kW (HP)	Gross 200 (267) at 2,600 rpm
Torque, Max. Nm (ft-lb)	785 (579) at 1,400 rpm
Capacity, liters (gal.)	
Cooling water	13 (3.4)
Lubrication	13-15 (3.4-4.0)
Fuel	300 (79.2)

## TRANSMISSION

Electronically controlled full automatic transmission. Torque converter driving full powershift with driving axle selector. 5 forward and 2 reverse speeds, constant mesh.

- 2 speeds - high range - 2 wheel drive; 4 wheel drive
- 3 speeds - low range - 4 wheel drive

## TRAVEL SPEED

15 km/h with counterweight  
4 km/h without counterweight

**GRADEABILITY ( $\tan \theta$ )** - 44% (with counterweight 29.3 t), 52% (with counterweight 18.2 t), 30%\*

\* Machine should be operated within the limit of engine crankcase design (17°: MITSUBISHI 6M60-TL).

## AXLE

1st: Full floating type, steering and driving axle with planetary reduction and open differential.

2nd: Steering and not driving axle.

3rd: Full floating type, steering and driving axle with planetary reduction and open differential.

## STEERING

Hydraulic power steering controlled by steering wheel. Four steering modes available: 2 wheel front, 4 wheel rear, 6 wheel coordinated and 6 wheel crab.

## SUSPENSION

1st: Rigid mounted to frame.

2nd and 3rd: "Hydro-Pneumatic suspension cylinders" with levering adjustment and oscillation.

## BRAKE SYSTEMS

Service: Air over hydraulic disc brakes on all 6 wheels. Parking/Emergency: Spring applied-air released brake acting on input shaft of 1st and 3rd axle.

Auxiliary: Electro-pneumatic operated exhaust brake.

**TIRES** - 26.5R25☆☆ Air pressure: 650 kPa

## OUTRIGGERS

Hydraulically operated H-type outrigger.

Vertical jack cylinders equipped with integral holding valve. Each outrigger beam and jack is controlled independently from cab.

Outrigger boxes are self-removable for ease of transportation.

Outrigger jack floats are attached thus eliminating the need of manually attaching and detaching them. Controls and sight level bubble located in superstructure cab. Four outrigger extension lengths are provided with corresponding "RATED LIFTING CAPACITIES" for crane duty in confined areas.

Min. Extension 2.99 m center to center  
Mid. Extension 5.50 m center to center

Mid. Extension 7.30 m center to center

Max. Extension 8.20 m center to center

Float size (Diameter) 0.57 m

## STANDARD EQUIPMENT

- Winch drum mirror
- Positive control
- 15° tilt cab
- Tilt-telescoping steering wheel
- Full instrumentation package
- Control pedals for boom elevating and boom telescoping
- 2nd and 3rd steer centering light
- Air cleaner dust indicator
- Aviation obstruction light
- Wind speed indicator
- Emergency steering system
- Over-unwinding prevention
- Additional weight 11.1 t
- Removable boom system
- Electronic crane monitoring system
- Fenders
- Air dryer
- Complete highway light package
- Towing hooks-Front and rear
- Hook block tie down (front bumper)
- Weighted hook storage compartment
- Halogen head lamp
- Self-removable outrigger boxes
- Independently controlled outriggers
- Self-storing outrigger pads
- Water separator with filter (high filtration)
- Back-up alarm
- Tool storage compartment
- Tire inflation kit
- Engine over-run alarm
- Lifting eyes
- Telematics (machine data logging and monitoring system) with HELLO-NET via internet (availability depends on countries)
- Eco mode system
- Self-removable counterweight

## OPTIONAL EQUIPMENT

- Search light
- Radiator cover
- Outrigger control box (Both side of carrier)
- Engine coolant heater (Diesel fuel type)
- Air heater (Diesel fuel type)
- Fuel filter heater
- Insert jib
- Short jib
- 100 ton - 8 sheaves with hook block and safety latch
- Additional sheave (Used at lifting more than 100 t)
- 45 ton - 3 sheaves with hook block and safety latch

## HOISTING PERFORMANCE

### LINE SPEEDS AND PULLS

Layer	Main or auxiliary winch - 0.382 m drum		
	Line speeds <sup>1</sup>		Line pulls Available <sup>2</sup>
	Low	High	Low
	m/min		kN (kgf)
1st	77	108	97.0 (9,900)
2nd	84	117	88.3 (9,010)
3rd	91	126	81.1 (8,270)
4th	97	136	74.9 (7,640)
5th	104	145	69.5 (7,090)
6th	110	154	64.9 (6,620)
7th <sup>3</sup>	117	163	60.8 (6,210)

- Maximum permissible line pull wire strength.  
70.6 kN (7,200 kgf) with 7 x 35 class rope.

- <sup>1</sup> Line speed based only on hook block, not loaded.
- <sup>2</sup> Developed by machinery with each layer of wire rope, but not based on rope strength or other limitations in machinery or equipment.
- <sup>3</sup> Seventh layer of wire rope are not recommended for hoisting operations.

### DRUM WIRE ROPE CAPACITIES

Wire rope layer	Main and auxiliary drum grooved lagging	
	19 mm wire rope	
	Rope per layer	Total wire rope
	Meter	
1	44.8	44.8
2	48.6	93.4
3	52.5	145.9
4	56.3	202.2
5	60.1	262.3
6	63.9	326.2
7	67.7	393.9

### DRUM DIMENSIONS (Main and auxiliary)

	mm
Root diameter	382
Length	742
Flange diameter	677

# GR-1450EX WORKING RANGE CHART

Manual offset jib
Counterweight 29.3 t

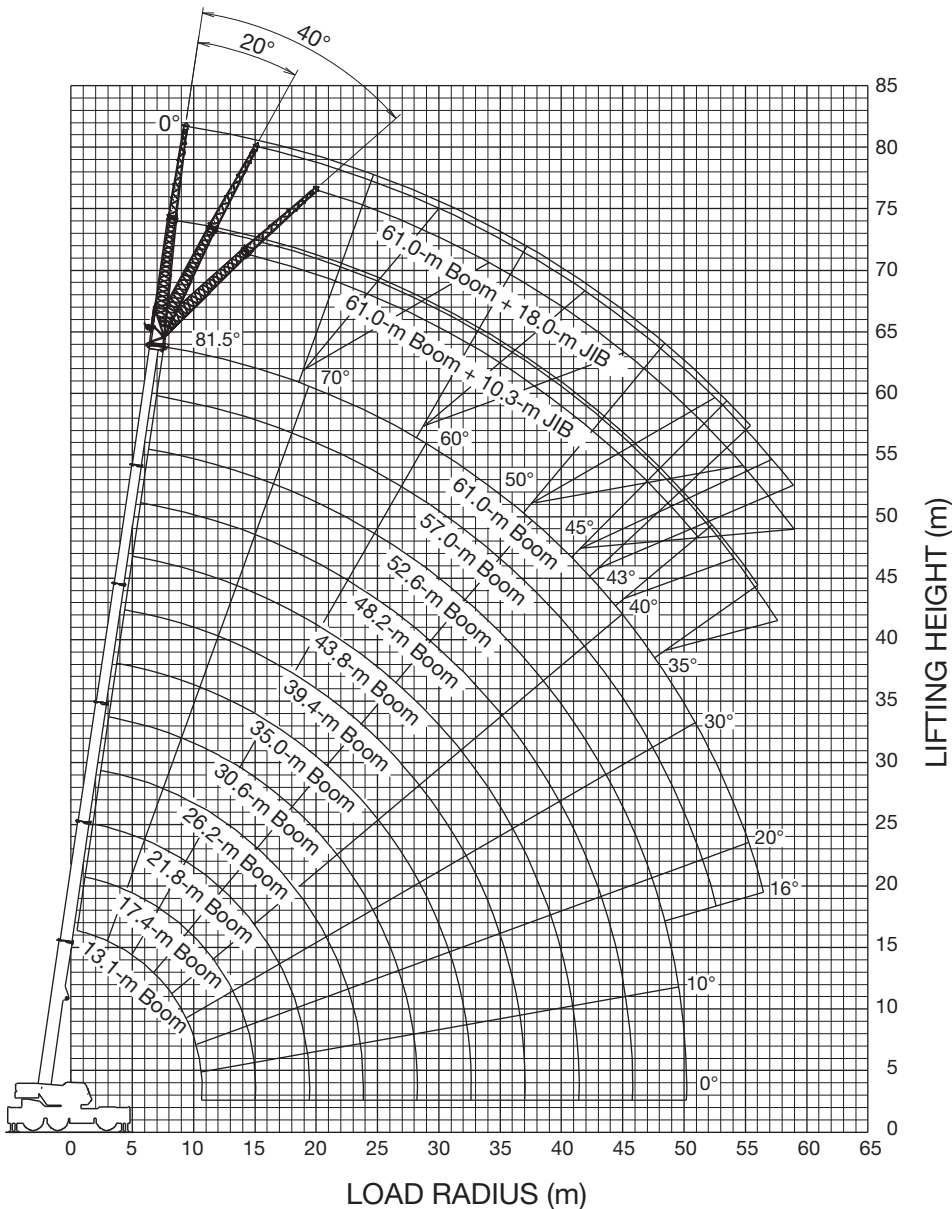

### BOOM

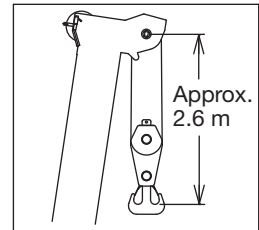

### JIB

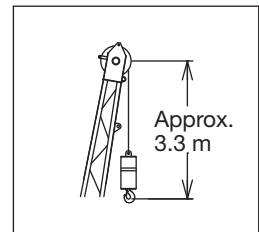

### SINGLE TOP

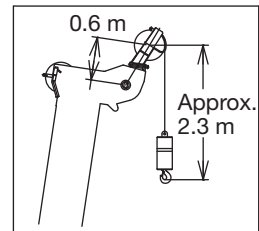

NOTE: Boom and jib geometry shown are for unloaded condition and machine standing level on firm supporting surface. Boom deflection and subsequent radius and boom angle change must be accounted for when applying load to hook.

# GR-1450EX WORKING RANGE CHART

Manual offset jib
7.0 m Insert jib *Option
Counterweight 29.3 t

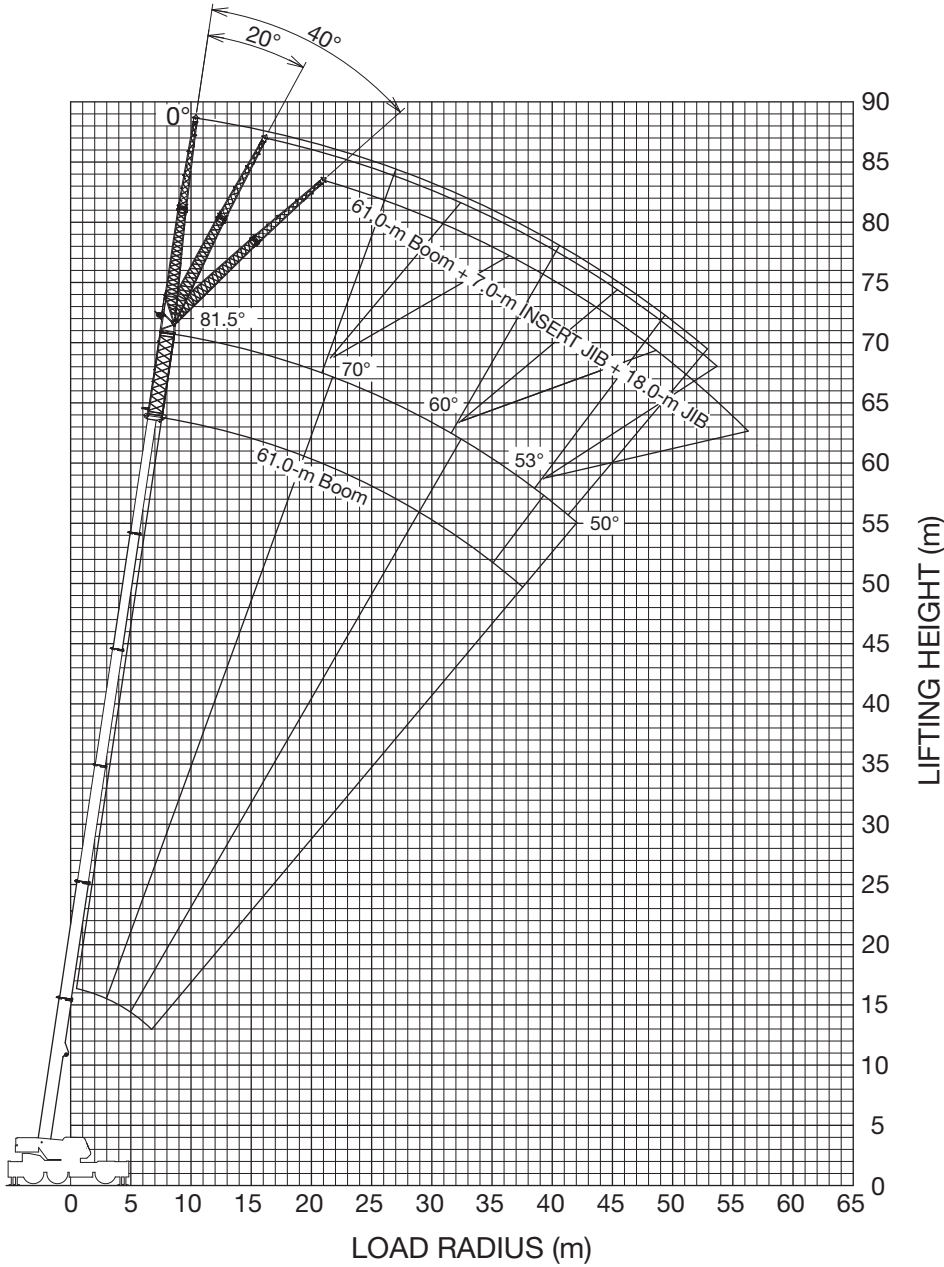

## BOOM

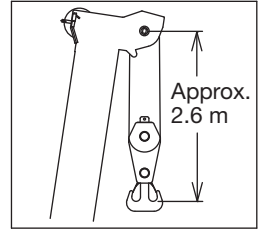

## JIB

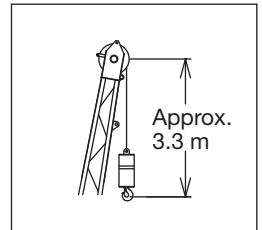

## SINGLE TOP

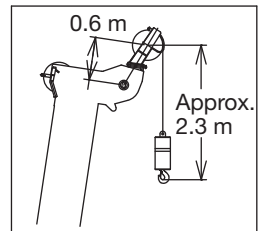

NOTE: Boom and jib geometry shown are for unloaded condition and machine standing level on firm supporting surface. Boom deflection and subsequent radius and boom angle change must be accounted for when applying load to hook.



# GR-1450EX WORKING RANGE CHART

Manual offset jib
14.0 m Insert jib *Option
Counterweight 29.3 t

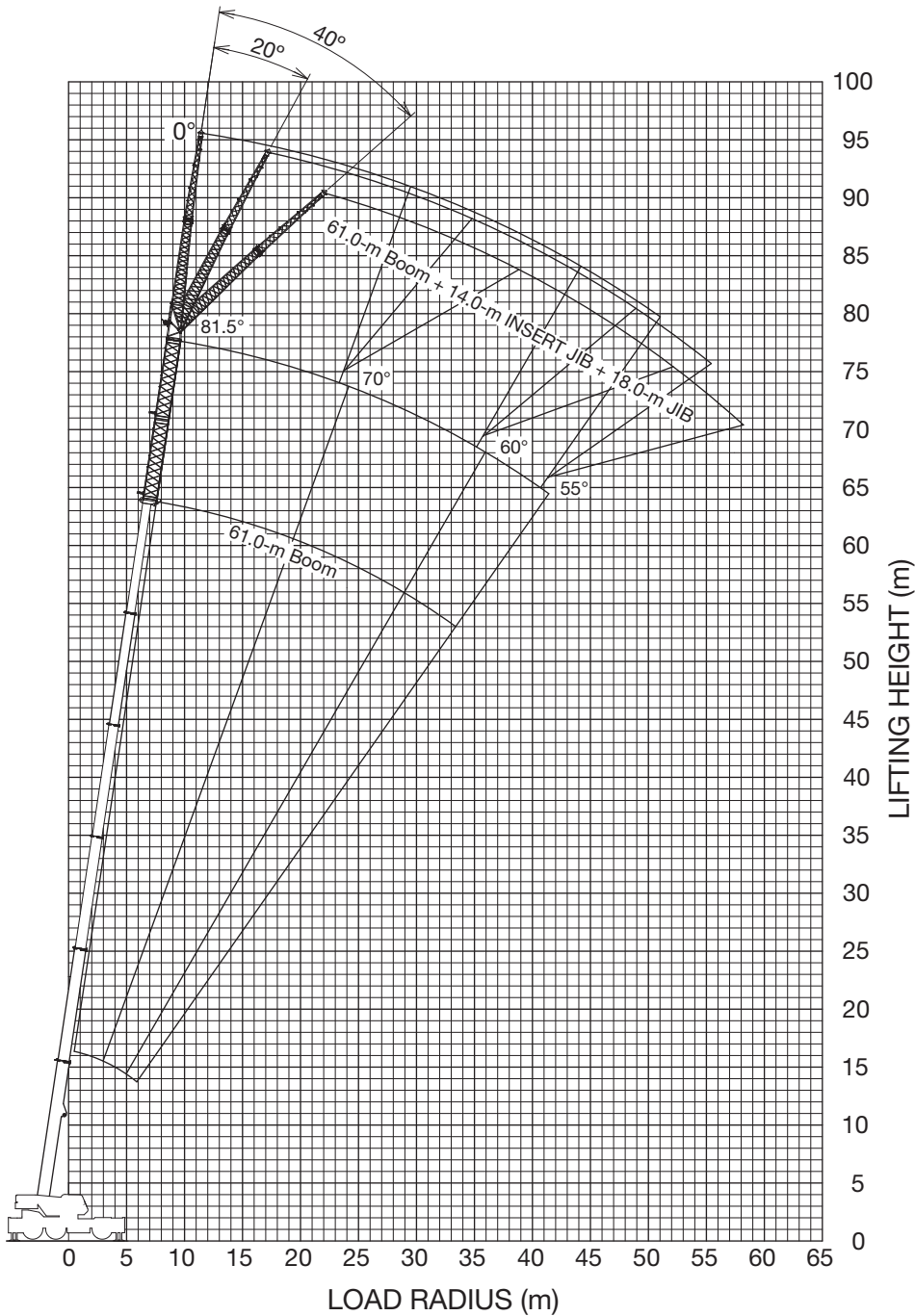

### BOOM

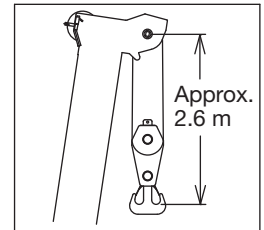

### JIB

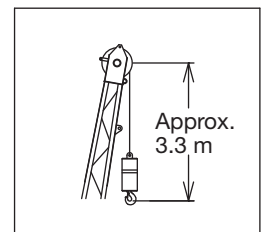

### SINGLE TOP

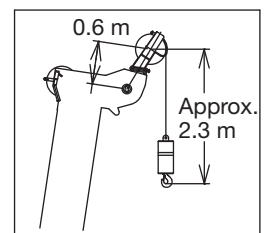

NOTE: Boom and jib geometry shown are for unloaded condition and machine standing level on firm supporting surface. Boom deflection and subsequent radius and boom angle change must be accounted for when applying load to hook.

# GR-1450EX WORKING RANGE CHART

Short jib *Option
Counterweight 29.3 t

## BOOM

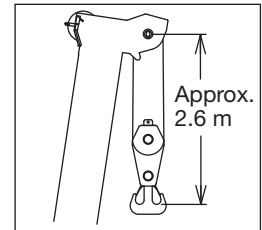

## JIB

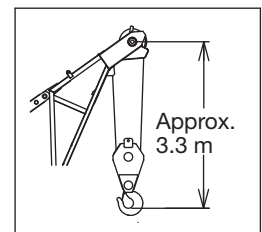

## SINGLE TOP

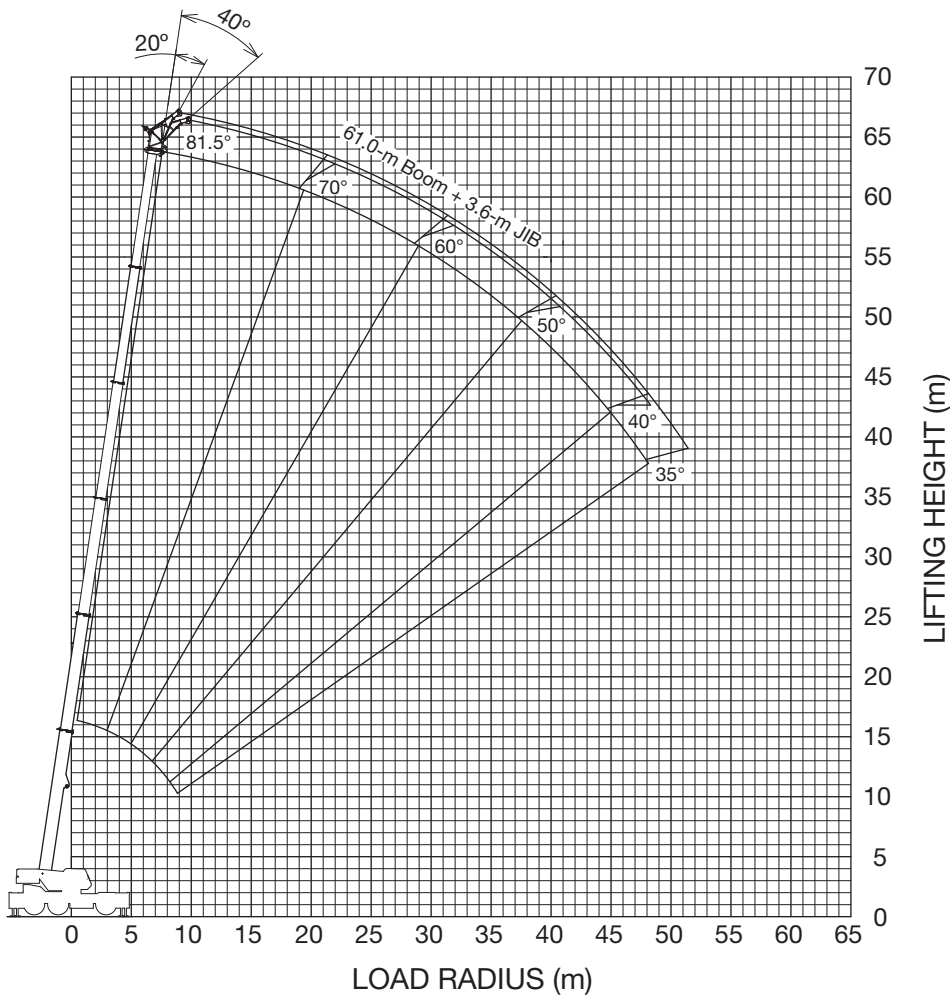
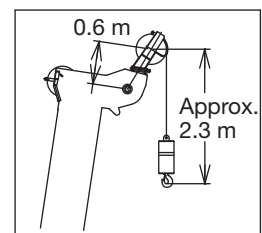

NOTE: Boom and jib geometry shown are for unloaded condition and machine standing level on firm supporting surface. Boom deflection and subsequent radius and boom angle change must be accounted for when applying load to hook.



# GR-1450EX RATED LIFTING CAPACITIES

## Boom

COUNTERWEIGHT 29.3 t ON OUTRIGGERS FULLY EXTENDED 8.2 m SPREAD 360° ROTATION (Unit: ×1,000 kg)												
A \ B	13.1 m	17.4 m	21.8 m	26.2 m	30.6 m	35.0 m	39.4 m	43.8 m	48.2 m	52.6 m	57.0 m	61.0 m
2.5	**145.0	90.7	79.0									
3.0	*110.6	90.7	79.0	37.0								
3.5	*101.5	90.7	79.0	66.0								
4.0	93.6	90.1	79.0	66.0	37.0							
4.5	85.9	83.7	79.0	66.0	48.2							
5.0	79.3	78.1	75.8	66.0	48.2	35.2						
5.5	73.5	73.2	71.0	66.0	48.2	35.2						
6.0	68.3	68.3	66.7	63.5	48.2	38.7						
6.5	63.7	64.1	63.6	60.5	48.2	37.5	30.1					
7.0	59.6	60.0	60.2	57.8	48.2	35.9	30.1					
7.5	56.0	56.4	56.5	55.3	48.2	35.2	30.1	22.1				
8.0	52.7	53.1	53.2	52.9	48.0	35.2	29.5	23.9				
9.0	46.8	47.3	47.5	47.2	44.8	35.2	27.9	23.9	17.2			
10.0	37.3	41.7	41.9	41.6	41.6	35.2	26.2	22.9	18.9	13.5		
11.0		37.1	37.3	37.5	37.7	33.2	24.4	22.0	18.9	15.0		
12.0		33.4	33.5	34.3	33.9	31.5	22.7	21.0	18.4	15.0	12.0	
14.0		27.8	27.6	28.4	28.0	28.4	20.9	19.2	16.9	15.0	12.0	10.4
16.0			23.3	24.0	24.3	24.3	19.3	17.1	15.5	14.1	12.0	10.4
18.0			21.2	20.2	21.3	20.7	17.8	15.4	14.3	13.1	12.0	10.4
20.0				18.1	17.8	17.3	16.5	14.0	12.9	12.1	11.2	10.2
22.0				15.4	15.2	14.6	15.2	12.7	11.8	11.2	10.4	9.6
24.0					13.0	13.6	13.1	11.7	10.8	10.4	9.8	9.0
26.0					11.3	11.9	11.4	10.8	10.1	9.6	9.1	8.4
28.0					8.2	10.5	9.9	9.6	9.4	8.8	8.5	7.8
30.0						9.3	8.7	9.1	8.6	8.2	8.0	7.3
32.0						8.3	7.7	8.0	7.5	7.7	7.4	6.7
34.0							6.8	7.1	6.9	7.0	6.6	6.2
36.0							6.1	6.3	6.5	6.2	5.8	5.8
38.0								5.9	5.8	5.5	5.1	5.1
40.0								5.5	5.2	4.9	4.5	4.5
42.0									4.6	4.4	3.9	3.9
44.0									4.2	3.9	3.4	3.4
46.0										3.4	3.0	3.0
48.0										3.1	2.6	2.6
50.0										2.7	2.2	2.2
52.0											1.9	1.9
54.0											1.7	1.6
56.0												1.3

\*\*Over front with special equipment

\*With special Equipment

A: Boom length (m)

B: Load radius (m)

NOTE: In this table, the thick line which divides strength area and stability area is not shown because the figure of this table is indicated the best performance at the same boom length among the plural telescopic boom patterns.

# GR-1450EX RATED LIFTING CAPACITIES

## Jib

COUNTERWEIGHT 29.3 t ON OUTRIGGERS FULLY EXTENDED 8.2 m SPREAD 360° ROTATION							COUNTERWEIGHT 29.3 t ON OUTRIGGERS FULLY EXTENDED 8.2 m SPREAD 360° ROTATION						
C	61.0-m Boom + 10.3-m Manual offset jib						C	57.0-m Boom + 10.3-m Manual offset jib					
	0° Tilt		20° Tilt		40° Tilt			0° Tilt		20° Tilt		40° Tilt	
	R	W	R	W	R	W		R	W	R	W	R	W
81.5	13.2	5.5	17.3	5.5	20.3	5.2	81.5	11.8	6.2	15.7	6.2	18.6	5.8
81	13.9	5.5	18.1	5.5	21.0	5.1	81	12.5	6.2	16.5	6.2	19.2	5.8
80	15.9	5.5	19.7	5.4	22.4	4.9	80	14.0	6.2	18.0	6.2	20.5	5.6
79	17.2	5.5	21.3	5.3	23.7	4.8	79	15.5	6.2	19.2	6.0	21.7	5.4
78	18.8	5.5	22.5	5.1	25.1	4.7	78	16.9	6.2	20.5	5.8	22.9	5.3
77	20.3	5.5	23.8	4.9	26.3	4.5	77	18.4	6.2	21.8	5.6	24.1	5.1
76	21.9	5.5	25.3	4.8	27.6	4.4	76	19.8	6.2	23.1	5.5	25.3	5.0
75	23.3	5.3	26.6	4.7	28.8	4.3	75	21.1	6.1	24.3	5.3	26.5	4.9
73	26.1	5.0	29.2	4.4	31.2	4.1	73	23.6	5.7	26.7	5.0	28.7	4.6
70	29.8	4.5	32.9	4.1	34.6	3.8	70	27.2	5.2	30.1	4.6	31.9	4.3
68	32.3	4.3	35.2	3.9	36.8	3.6	68	29.4	4.9	32.4	4.4	34.0	4.1
65	35.9	4.0	38.6	3.6	39.9	3.4	65	32.7	4.5	35.6	4.1	37.0	3.9
63	38.0	3.7	40.8	3.5	42.0	3.3	63	35.0	4.3	37.5	3.9	38.9	3.7
60	41.3	3.4	43.7	3.2	45.0	3.1	60	38.0	4.0	40.5	3.7	41.8	3.6
58	43.4	3.2	45.8	3.0	46.7	2.9	58	40.1	3.9	42.5	3.6	43.4	3.4
55	46.4	3.0	48.6	2.8	49.4	2.7	55	42.9	3.6	45.2	3.4	46.1	3.3
53	48.2	2.8	50.4	2.7	51.1	2.6	53	44.6	3.4	46.9	3.3	47.6	3.2
50	50.8	2.5	52.6	2.3	53.1	2.2	50	47.2	3.2	49.1	3.0	49.6	2.8
48	52.2	2.2	54.0	2.0	54.5	1.9	48	48.7	2.9	50.5	2.7	50.9	2.6
45	54.3	1.8	56.1	1.7	56.4	1.6	45	50.7	2.4	52.4	2.3	52.8	2.2
43	55.7	1.6	57.3	1.4			43	52.1	2.2	53.6	2.0		
40	57.7	1.3	59.2	1.2			40	54.0	1.8	55.4	1.7		
38	58.9	1.1	60.2	1.0			38	55.2	1.6	56.4	1.5		
35	60.8	0.9	61.8	0.8			35	56.9	1.4	58.0	1.3		
33							33	57.9	1.2	58.9	1.2		
30							30	59.5	1.1	60.0	1.0		
28							28	60.3	0.9	60.9	0.9		
25							25	61.5	0.8	61.9	0.8		
G			1				G			1			

COUNTERWEIGHT 29.3 t ON OUTRIGGERS FULLY EXTENDED 8.2 m SPREAD 360° ROTATION							COUNTERWEIGHT 29.3 t ON OUTRIGGERS FULLY EXTENDED 8.2 m SPREAD 360° ROTATION						
C	52.6-m Boom + 10.3-m Manual offset jib						C	35.0-m Boom + 10.3-m Manual offset jib					
	0° Tilt		20° Tilt		40° Tilt			0° Tilt		20° Tilt		40° Tilt	
	R	W	R	W	R	W		R	W	R	W	R	W
81.5	10.3	7.2	14.3	7.2	17.3	6.8	81.5			8.9	10.6	11.3	7.3
81	10.9	7.2	14.9	7.2	17.9	6.7	81			9.3	10.5	11.7	7.2
80	12.3	7.2	16.3	7.2	19.1	6.5	80			10.1	10.2	12.5	7.1
79	13.7	7.2	17.6	7.1	20.2	6.3	79			10.9	10.0	13.2	7.0
78	15.0	7.2	18.8	6.9	21.4	6.1	78			11.9	9.7	14.0	6.9
77	16.4	7.2	19.7	6.6	22.5	6.0	77			12.6	9.5	14.8	6.9
76	17.6	7.2	21.1	6.4	23.5	5.8	76			13.3	9.3	15.5	6.8
75	19.0	7.2	22.2	6.2	24.6	5.7	75	11.3	14.1	14.1	9.1	16.2	6.7
73	21.3	6.8	24.4	5.9	26.7	5.4	73	12.9	13.2	15.6	8.7	17.6	6.5
70	24.8	6.2	27.7	5.4	29.6	5.0	70	15.2	12.2	17.9	8.2	19.6	6.3
68	26.9	5.9	29.7	5.2	31.5	4.8	68	16.7	11.6	19.3	7.9	21.0	6.2
65	30.1	5.4	32.7	4.9	34.3	4.6	65	18.9	10.8	21.4	7.6	22.9	6.1
63	32.1	5.2	34.6	4.7	36.0	4.4	63	20.3	10.4	22.8	7.4	24.2	6.0
60	35.0	4.8	37.4	4.4	38.7	4.2	60	22.4	9.9	24.8	7.1	26.0	5.9
58	36.8	4.5	39.2	4.2	40.4	4.1	58	23.7	9.6	26.0	6.9	27.2	5.8
55	39.5	4.2	41.6	4.0	42.6	3.8	55	25.7	9.1	27.8	6.7	28.9	5.8
53	41.1	4.0	43.2	3.8	44.1	3.7	53	26.8	8.7	29.0	6.5	29.9	5.7
50	43.6	3.8	45.4	3.5	46.0	3.4	50	28.6	8.3	30.6	6.4	31.5	5.7
48	44.9	3.4	46.6	3.2	47.2	3.1	48	29.7	8.0	31.7	6.3	32.4	5.7
45	46.8	2.9	48.5	2.7	48.9	2.6	45	31.4	7.7	33.2	6.1	33.8	5.6
43	48.1	2.7	49.6	2.5			43	32.4	7.5	34.1	6.1		
40	49.9	2.3	51.2	2.1			40	33.9	7.2	35.5	6.0		
38	51.1	2.1	52.3	1.9			38	34.9	6.9	36.3	5.9		
35	52.9	1.8	54.0	1.7			35	36.1	6.4	37.5	5.9		
33	53.8	1.6	54.9	1.5			33	36.9	6.1	38.1	5.8		
30	55.3	1.4	56.1	1.3			30	38.1	5.7	39.1	5.4		
28	56.1	1.3	56.8	1.2			28	38.7	5.4	39.7	5.2		
25	57.3	1.1	57.7	1.1			25	39.7	5.2	40.4	5.0		
23	57.9	1.0					23	40.3	5.0				
20	58.8	0.9					20	41.0	4.8				
G			1				G			2			

C: Loaded boom angle (°)  
 R: Load radius (m)  
 W: Rated lifting capacity (Unit: x 1,000 kg)  
 G: Number of parts of line

# GR-1450EX RATED LIFTING CAPACITIES

## Jib

COUNTERWEIGHT 29.3 t ON OUTRIGGERS FULLY EXTENDED 8.2 m SPREAD 360° ROTATION							COUNTERWEIGHT 29.3 t ON OUTRIGGERS FULLY EXTENDED 8.2 m SPREAD 360° ROTATION						
C	61.0-m Boom + 18.0-m Manual offset jib						C	57.0-m Boom + 18.0-m Manual offset jib					
	0° Tilt		20° Tilt		40° Tilt			0° Tilt		20° Tilt		40° Tilt	
	R	W	R	W	R	W		R	W	R	W	R	W
81.5	15.1	3.7	22.4	3.7	27.2	3.2	81.5	13.3	4.0	20.2	4.0	24.8	3.3
81	16.1	3.7	23.0	3.7	28.2	3.2	81	14.1	4.0	21.1	4.0	25.6	3.3
80	17.7	3.7	25.0	3.7	29.6	3.1	80	15.7	4.0	22.7	4.0	27.1	3.3
79	19.6	3.7	26.7	3.7	31.2	3.1	79	17.3	4.0	24.2	3.9	28.3	3.2
78	21.5	3.7	28.3	3.6	32.6	3.0	78	19.0	4.0	25.7	3.8	29.8	3.2
77	23.0	3.7	29.8	3.5	34.0	3.0	77	20.6	4.0	27.1	3.7	31.0	3.1
76	24.9	3.7	31.4	3.4	35.4	3.0	76	22.2	4.0	28.6	3.7	32.4	3.1
75	26.6	3.7	32.7	3.3	36.6	2.9	75	23.8	4.0	30.0	3.6	33.6	3.1
73	29.7	3.7	35.5	3.1	39.3	2.9	73	26.9	4.0	32.7	3.5	36.0	3.0
70	33.9	3.4	39.3	2.9	42.8	2.7	70	31.3	4.0	36.6	3.3	39.5	2.9
68	36.7	3.3	41.9	2.8	45.1	2.6	68	34.0	3.8	39.1	3.2	41.6	2.8
65	40.6	3.0	45.6	2.6	48.2	2.4	65	37.7	3.5	42.5	3.0	44.8	2.8
63	43.3	2.9	47.9	2.5	50.5	2.4	63	40.2	3.4	44.7	2.9	46.8	2.7
60	46.8	2.6	51.3	2.4	53.3	2.2	60	43.6	3.1	48.0	2.8	49.8	2.6
58	49.2	2.5	53.3	2.2	55.3	2.2	58	45.9	3.0	50.0	2.7	51.5	2.5
55	52.4	2.3	56.3	2.1	57.8	2.0	55	49.0	2.8	52.8	2.5	54.1	2.4
53	54.3	2.1	58.0	1.9	59.1	1.7	53	50.9	2.6	54.6	2.4	55.5	2.2
50	56.8	1.7	60.1	1.5	60.9	1.3	50	53.5	2.3	56.8	2.0	57.4	1.9
48	58.6	1.5	61.7	1.3	62.2	1.1	48	55.0	2.0	58.2	1.8	58.6	1.6
45	60.8	1.1	63.7	1.0	64.1	0.9	45	57.3	1.7	60.2	1.5	60.4	1.3
43	62.3	0.9	64.9	0.8			43	58.8	1.5	61.4	1.3		
40							40	60.8	1.2	63.1	1.0		
38							38	62.1	1.0	64.3	0.9		
35							35	64.0	0.8				
G			1				G			1			

COUNTERWEIGHT 29.3 t ON OUTRIGGERS FULLY EXTENDED 8.2 m SPREAD 360° ROTATION							COUNTERWEIGHT 29.3 t ON OUTRIGGERS FULLY EXTENDED 8.2 m SPREAD 360° ROTATION						
C	52.6-m Boom + 18.0-m Manual offset jib						C	35.0-m Boom + 18.0-m Manual offset jib					
	0° Tilt		20° Tilt		40° Tilt			0° Tilt		20° Tilt		40° Tilt	
	R	W	R	W	R	W		R	W	R	W	R	W
81.5	12.0	4.7	18.7	4.4	23.2	3.4	81.5	7.4	6.4	13.3	5.4	18.0	3.7
81	12.8	4.7	19.4	4.4	23.8	3.4	81	8.0	6.4	13.7	5.3	18.4	3.7
80	14.3	4.7	20.9	4.3	25.3	3.4	80	9.0	6.4	14.7	5.2	19.3	3.6
79	15.9	4.7	22.2	4.2	26.5	3.3	79	10.2	6.4	15.7	5.1	20.1	3.6
78	17.3	4.7	23.5	4.1	27.7	3.3	78	11.1	6.4	16.6	5.0	20.9	3.6
77	18.8	4.7	24.9	4.0	28.9	3.3	77	12.1	6.4	17.5	4.8	21.7	3.5
76	20.1	4.7	26.2	3.9	30.1	3.2	76	13.0	6.4	18.5	4.7	22.5	3.5
75	21.7	4.7	27.5	3.9	31.2	3.2	75	14.0	6.4	19.3	4.6	23.4	3.5
73	24.7	4.7	30.0	3.7	33.4	3.1	73	15.8	6.4	21.2	4.5	24.9	3.4
70	28.7	4.7	33.7	3.6	36.7	3.0	70	18.7	6.3	22.7	4.2	27.1	3.3
68	31.2	4.5	36.1	3.5	38.8	3.0	68	20.3	6.0	25.4	4.1	28.5	3.2
65	34.8	4.2	39.4	3.3	41.6	2.9	65	22.9	5.6	27.8	3.9	30.7	3.2
63	37.0	4.0	41.4	3.2	43.5	2.9	63	24.6	5.3	29.4	3.8	32.0	3.2
60	40.3	3.8	44.5	3.1	46.3	2.8	60	27.1	5.0	31.6	3.6	34.0	3.1
58	42.3	3.6	46.4	3.1	48.1	2.8	58	28.7	4.8	33.0	3.6	35.3	3.1
55	45.3	3.3	49.3	3.0	50.6	2.8	55	30.9	4.6	35.0	3.4	37.1	3.1
53	47.1	3.2	51.0	2.9	52.0	2.7	53	32.4	4.4	36.5	3.4	38.1	3.0
50	49.7	2.8	53.2	2.5	53.8	2.3	50	34.5	4.2	38.3	3.3	39.7	3.0
48	51.3	2.5	54.5	2.2	55.0	2.0	48	35.9	4.1	39.6	3.3	40.7	3.0
45	53.6	2.1	56.4	1.8	56.7	1.7	45	37.7	3.9	41.1	3.2	42.0	3.0
43	55.1	1.9	57.7	1.6			43	39.0	3.8	42.2	3.2		
40	57.1	1.6	59.5	1.4			40	40.7	3.7	43.7	3.1		
38	58.5	1.4	60.6	1.2			38	41.8	3.6	44.5	3.1		
35	60.4	1.1	62.1	1.0			35	43.3	3.5	45.8	3.1		
33	61.7	1.0	63.0	0.9			33	44.3	3.4	46.5	3.1		
30	63.3	0.8					30	45.7	3.3	47.5	3.1		
28							28	46.5	3.3	48.1	3.1		
25							25	47.6	3.2	48.8	3.1		
23							23	48.3	3.2				
20							20	49.1	3.1				
G			1				G			1			

C: Loaded boom angle (°)  
R: Load radius (m)  
W: Rated lifting capacity (Unit: x 1,000 kg)  
G: Number of parts of line

# GR-1450EX RATED LIFTING CAPACITIES

## Jib

COUNTERWEIGHT 29.3 t							COUNTERWEIGHT 29.3 t						
ON OUTRIGGERS FULLY EXTENDED 8.2 m SPREAD							ON OUTRIGGERS FULLY EXTENDED 8.2 m SPREAD						
360° ROTATION							360° ROTATION						
C	61.0-m Boom + 7.0-m Insert jib + 18.0-m Manual offset jib						C	57.0-m Boom + 7.0-m Insert jib + 18.0-m Manual offset jib					
	0° Tilt		20° Tilt		40° Tilt			0° Tilt		20° Tilt		40° Tilt	
	R	W	R	W	R	W		R	W	R	W	R	W
81.5	17.6	3.1	24.3	2.9	29.1	2.6	81.5	15.7	3.4	22.3	3.2	27.0	2.7
81	18.6	3.1	25.3	2.9	30.0	2.6	81	16.8	3.4	23.2	3.2	27.9	2.7
80	20.6	3.1	27.4	2.9	31.9	2.6	80	18.6	3.4	25.1	3.2	29.5	2.7
79	22.6	3.1	29.3	2.9	33.6	2.6	79	20.3	3.4	26.9	3.2	31.2	2.7
78	24.6	3.1	30.9	2.8	35.1	2.5	78	22.2	3.4	28.7	3.2	32.7	2.7
77	26.6	3.1	32.6	2.7	36.7	2.5	77	24.0	3.4	30.2	3.1	34.0	2.6
76	28.4	3.1	34.1	2.6	38.2	2.4	76	25.9	3.4	31.7	3.0	35.6	2.6
75	30.1	3.0	35.6	2.5	39.5	2.3	75	27.4	3.4	33.1	2.9	36.8	2.5
73	33.3	2.8	38.7	2.4	42.2	2.2	73	30.6	3.2	35.9	2.7	39.7	2.5
70	38.0	2.5	43.1	2.2	46.0	2.0	70	34.9	2.9	40.2	2.6	43.6	2.4
68	41.2	2.4	45.9	2.1	48.5	1.9	68	38.1	2.9	42.7	2.4	46.0	2.3
65	45.5	2.2	49.7	1.9	52.1	1.8	65	42.0	2.6	46.6	2.3	49.3	2.2
63	48.2	2.1	52.2	1.8	54.4	1.7	63	44.6	2.5	49.1	2.2	51.5	2.1
60	52.0	1.9	56.0	1.7	57.7	1.6	60	48.3	2.3	52.7	2.1	54.7	2.0
58	54.4	1.8	58.4	1.7	59.9	1.6	58	50.8	2.2	54.9	2.0	56.6	1.9
55	57.6	1.5	61.1	1.3	62.2	1.2	55	54.4	2.1	57.9	1.8	59.1	1.7
53	59.6	1.3	62.7	1.0	63.7	1.0	53	56.1	1.8	59.4	1.5	60.6	1.4
50	62.1	0.9					50	58.8	1.4	61.9	1.2	62.5	1.1
48							48	60.4	1.2	63.2	1.0	63.9	0.9
45							45	62.6	0.9				
43							43	64.6	0.8				
40							40						
38							38						
35							35						
33							33						
30							30						
28							28						
25							25						
23							23						
G				1			G				1		

COUNTERWEIGHT 29.3 t							COUNTERWEIGHT 29.3 t						
ON OUTRIGGERS FULLY EXTENDED 8.2 m SPREAD							ON OUTRIGGERS FULLY EXTENDED 8.2 m SPREAD						
360° ROTATION							360° ROTATION						
C	52.6-m Boom + 7.0-m Insert jib + 18.0-m Manual offset jib						C	35.0-m Boom + 7.0-m Insert jib + 18.0-m Manual offset jib					
	0° Tilt		20° Tilt		40° Tilt			0° Tilt		20° Tilt		40° Tilt	
	R	W	R	W	R	W		R	W	R	W	R	W
81.5	14.1	3.9	20.8	3.6	25.1	2.8	81.5	8.6	5.4	14.7	4.5	19.4	3.3
81	15.0	3.9	21.6	3.6	25.8	2.8	81	9.1	5.4	15.3	4.5	19.9	3.3
80	16.7	3.9	23.4	3.6	27.4	2.8	80	10.3	5.4	16.5	4.5	21.0	3.3
79	18.4	3.9	24.8	3.5	28.9	2.8	79	11.4	5.4	17.6	4.4	22.2	3.3
78	20.1	3.9	26.3	3.4	30.3	2.8	78	12.6	5.4	18.8	4.3	22.9	3.2
77	21.7	3.9	27.8	3.3	31.6	2.7	77	13.7	5.4	19.6	4.1	23.8	3.1
76	23.3	3.9	29.2	3.2	32.9	2.7	76	14.9	5.4	20.6	4.0	25.0	3.1
75	24.9	3.9	30.6	3.1	34.1	2.6	75	16.0	5.4	21.8	3.9	25.7	3.0
73	28.2	3.9	33.3	3.0	36.6	2.5	73	18.3	5.4	23.6	3.6	27.6	2.9
70	32.3	3.6	37.3	2.8	40.2	2.4	70	21.3	4.9	26.7	3.4	30.0	2.7
68	35.1	3.5	39.8	2.7	42.6	2.4	68	23.3	4.6	28.4	3.2	31.7	2.6
65	39.0	3.2	43.6	2.6	45.9	2.3	65	26.1	4.1	31.1	3.0	34.0	2.5
63	41.5	3.1	45.9	2.5	47.9	2.2	63	28.0	3.9	33.0	2.9	35.6	2.4
60	45.1	2.9	49.2	2.4	51.0	2.2	60	30.7	3.5	35.3	2.7	37.9	2.3
58	47.2	2.7	51.3	2.3	52.8	2.1	58	32.4	3.3	36.9	2.6	39.5	2.3
55	50.5	2.5	54.2	2.2	55.7	2.1	55	35.1	3.1	39.4	2.5	41.3	2.2
53	52.2	2.3	55.9	2.0	56.8	1.8	53	36.7	3.0	40.7	2.4	42.8	2.2
50	54.9	1.9	58.2	1.6	59.0	1.5	50	39.1	2.8	42.9	2.3	44.4	2.1
48	56.5	1.6	59.7	1.4	60.2	1.3	48	40.7	2.7	44.2	2.2	45.6	2.1
45	58.9	1.3	61.8	1.1	62.1	1.0	45	42.8	2.5	46.4	2.2	47.0	2.0
43	60.3	1.1	62.9	0.9			43	44.2	2.5	47.3	2.1		
40	62.4	0.9					40	46.1	2.3	49.2	2.1		
38							38	47.4	2.3	50.0	2.0		
35							35	49.1	2.2	51.6	2.0		
33							33	50.1	2.1	52.5	2.0		
30							30	51.6	2.1	53.4	1.9		
28							28	52.5	2.0	54.0	1.9		
25							25	53.7	2.0	54.9	1.9		
23							23	54.4	2.0				
G				1			G				1		

C: Loaded boom angle (°)  
 R: Load radius (m)  
 W: Rated lifting capacity (Unit: x 1,000 kg)  
 G: Number of parts of line

# GR-1450EX RATED LIFTING CAPACITIES

## Jib

COUNTERWEIGHT 29.3 t ON OUTRIGGERS FULLY EXTENDED 8.2 m SPREAD 360° ROTATION							Insert jib: Option						
C	61.0-m Boom + 14.0-m Insert jib + 18.0-m Manual offset jib						C	57.0-m Boom + 14.0-m Insert jib + 18.0-m Manual offset jib					
	0° Tilt		20° Tilt		40° Tilt			0° Tilt		20° Tilt		40° Tilt	
	R	W	R	W	R	W		R	W	R	W	R	W
81.5	19.8	2.1	26.4	2.1	32.1	2.1	81.5	18.2	2.8	24.5	2.4	29.6	2.2
81	21.0	2.1	27.5	2.1	33.1	2.1	81	19.3	2.8	25.5	2.4	30.6	2.2
80	23.2	2.1	29.8	2.1	35.2	2.1	80	21.3	2.8	27.6	2.4	32.6	2.2
79	25.4	2.1	31.8	2.1	36.8	2.0	79	23.4	2.8	29.5	2.4	34.2	2.2
78	27.5	2.1	33.8	2.1	38.7	2.0	78	25.5	2.8	31.1	2.3	35.8	2.1
77	29.5	2.1	35.6	2.0	40.2	1.9	77	27.2	2.7	33.0	2.3	37.2	2.0
76	31.7	2.1	37.6	2.0	41.7	1.8	76	29.0	2.6	34.6	2.2	38.8	2.0
75	33.6	2.1	39.2	1.9	43.4	1.8	75	30.7	2.5	36.1	2.1	40.2	1.9
73	37.4	2.0	42.7	1.8	46.2	1.6	73	34.1	2.3	39.4	2.0	43.3	1.9
70	42.6	1.8	47.3	1.6	50.5	1.5	70	39.0	2.1	44.0	1.9	47.2	1.7
68	45.9	1.7	50.4	1.5	53.4	1.4	68	42.2	2.0	47.1	1.8	50.2	1.7
65	50.6	1.5	54.7	1.3	57.3	1.3	65	46.6	1.8	51.1	1.6	54.0	1.6
63	53.5	1.4	57.6	1.3	59.8	1.2	63	49.7	1.8	53.9	1.6	56.4	1.5
60	58.0	1.3	61.6	1.2	63.3	1.1	60	53.6	1.6	57.7	1.5	59.8	1.4
58	60.7	1.2	64.0	1.1	65.5	1.0	58	56.2	1.5	60.0	1.4	61.9	1.4
55	64.0	0.9	67.0	0.8	68.6	0.8	55	60.0	1.4	63.4	1.3	64.7	1.2
53							53	62.1	1.2	65.2	1.1	66.4	1.1
50							50	65.3	1.0	68.1	0.9	69.0	0.8
48							48	67.3	0.8				
45							45						
43							43						
40							40						
38							38						
35							35						
33							33						
30							30						
28							28						
25							25						
23							23						
G			1				G			1			

COUNTERWEIGHT 29.3 t ON OUTRIGGERS FULLY EXTENDED 8.2 m SPREAD 360° ROTATION							Insert jib: Option						
C	52.6-m Boom + 14.0-m Insert jib + 18.0-m Manual offset jib						C	35.0-m Boom + 14.0-m Insert jib + 18.0-m Manual offset jib					
	0° Tilt		20° Tilt		40° Tilt			0° Tilt		20° Tilt		40° Tilt	
	R	W	R	W	R	W		R	W	R	W	R	W
81.5	16.4	3.2	22.4	2.7	27.5	2.4	81.5	10.4	4.4	16.4	3.6	21.2	2.9
81	17.4	3.2	23.4	2.7	28.2	2.4	81	11.1	4.4	17.1	3.6	21.9	2.9
80	19.4	3.2	25.3	2.7	30.1	2.4	80	12.5	4.4	18.4	3.6	23.0	2.9
79	21.3	3.2	27.1	2.7	31.7	2.4	79	13.8	4.4	19.6	3.5	24.1	2.8
78	23.1	3.2	28.6	2.6	33.1	2.3	78	15.1	4.4	20.8	3.4	25.4	2.8
77	24.9	3.1	30.1	2.5	34.5	2.2	77	16.4	4.4	22.0	3.3	26.3	2.7
76	26.5	3.0	31.7	2.4	36.1	2.2	76	17.6	4.3	23.2	3.2	27.4	2.6
75	28.1	2.9	33.4	2.4	37.3	2.1	75	18.9	4.1	24.4	3.1	28.3	2.5
73	31.3	2.7	36.1	2.2	40.2	2.0	73	21.1	3.8	26.4	2.9	30.4	2.4
70	36.0	2.5	40.6	2.1	44.1	1.9	70	24.6	3.4	29.8	2.7	33.3	2.2
68	38.9	2.3	43.4	2.0	46.6	1.8	68	26.8	3.2	31.9	2.5	35.2	2.1
65	43.3	2.2	47.2	1.8	50.2	1.7	65	30.1	2.9	34.9	2.3	37.7	1.9
63	45.8	2.0	49.7	1.7	52.5	1.6	63	32.3	2.8	36.7	2.1	39.5	1.8
60	49.8	1.9	53.4	1.6	55.9	1.5	60	35.2	2.5	39.5	2.0	42.0	1.7
58	52.3	1.8	55.9	1.6	58.0	1.5	58	37.3	2.4	41.4	1.9	43.6	1.6
55	56.0	1.7	59.2	1.5	60.9	1.4	55	40.0	2.1	43.9	1.7	45.9	1.5
53	58.1	1.6	61.4	1.5	62.8	1.4	53	41.8	2.0	45.6	1.6	47.5	1.5
50	61.0	1.3	64.1	1.3	65.1	1.2	50	44.5	1.9	48.0	1.5	49.4	1.4
48	63.0	1.2	65.7	1.1	66.3	1.0	48	46.2	1.8	49.7	1.5	50.9	1.4
45	65.3	0.9	67.8	0.8			45	48.5	1.6	51.8	1.4	52.5	1.3
43							43	50.2	1.6	53.2	1.4		
40							40	52.2	1.5	55.1	1.3		
38							38	53.6	1.4	56.2	1.3		
35							35	55.4	1.3	57.6	1.2		
33							33	56.6	1.3	58.7	1.2		
30							30	58.2	1.2	59.8	1.1		
28							28	59.1	1.2	60.5	1.1		
25							25	60.4	1.1	61.7	1.1		
23							23	61.2	1.1				
G			1				G			1			

C: Loaded boom angle (°)  
R: Load radius (m)  
W: Rated lifting capacity (Unit: x 1,000 kg)  
G: Number of parts of line

# GR-1450EX RATED LIFTING CAPACITIES

## Jib

COUNTERWEIGHT 29.3 t ON OUTRIGGERS FULLY EXTENDED 8.2 m SPREAD 360° ROTATION									
61.0-m Boom + 3.6-m Short jib					57.0-m Boom + 3.6-m Short jib				
C	20° Tilt		40° Tilt		C	20° Tilt		40° Tilt	
	R	W	R	W		R	W	R	W
81.5	14.1	9.4	15.6	9.2	81.5	12.7	10.8	13.6	10.5
81	14.8	9.2	16.2	9.1	81	13.3	10.7	14.2	10.3
80	16.1	9.0	17.5	8.8	80	14.5	10.3	15.4	10.0
79	17.4	8.7	18.7	8.5	79	15.5	10.0	16.4	9.6
78	18.5	8.4	19.8	8.2	78	16.6	9.6	17.6	9.3
77	19.7	8.1	20.9	7.9	77	17.8	9.3	18.6	9.0
76	20.9	7.8	22.1	7.7	76	18.8	9.0	19.6	8.7
75	22.0	7.5	23.2	7.4	75	19.9	8.7	20.7	8.4
73	24.3	7.0	25.3	6.9	73	22.0	8.1	22.7	7.9
70	27.4	6.3	28.5	6.2	70	25.0	7.4	25.7	7.3
68	29.5	5.9	30.4	5.8	68	26.9	6.9	27.6	6.8
65	32.5	5.3	33.4	5.3	65	29.8	6.3	30.3	6.2
63	34.4	5.0	35.2	4.9	63	31.6	6.0	32.2	5.9
60	37.2	4.5	37.7	4.4	60	34.2	5.4	34.6	5.4
58	38.9	4.1	38.7	3.9	58	35.9	5.1	36.3	4.9
55	41.2	3.4	41.5	3.2	55	38.2	4.3	38.4	4.2
53	42.7	3.0	43.0	2.8	53	39.6	3.9	39.8	3.7
50	44.9	2.5	45.0	2.3	50	41.7	3.3	41.8	3.1
48	46.4	2.2	46.4	2.0	48	43.0	2.9	43.1	2.8
45	48.4	1.8	48.4	1.7	45	44.9	2.5	44.9	2.4
43	49.6	1.5	49.6	1.4	43	46.1	2.2	46.1	2.1
40	51.5	1.2	51.5	1.1	40	47.9	1.9	47.8	1.8
38	52.6	1.0			38	48.9	1.7		
35	54.1	0.8			35	50.4	1.4		
33					33	51.4	1.3		
30					30	52.7	1.1		
28					28	53.4	1.0		
25					25	54.4	0.8		
20					20				
G			2		G			2	

COUNTERWEIGHT 29.3 t ON OUTRIGGERS FULLY EXTENDED 8.2 m SPREAD 360° ROTATION									
52.6-m Boom + 3.6-m Short jib					35.0-m Boom + 3.6-m Short jib				
C	20° Tilt		40° Tilt		C	20° Tilt		40° Tilt	
	R	W	R	W		R	W	R	W
81.5	11.2	13.1	12.1	12.6	81.5	6.5	22.2	6.9	18.0
81	11.8	12.9	12.7	12.4	81	6.8	22.0	7.2	17.9
80	12.9	12.4	13.8	11.9	80	7.5	21.7	7.9	17.7
79	13.9	12.0	14.8	11.5	79	8.2	21.3	8.6	17.5
78	15.0	11.6	15.8	11.1	78	8.9	21.0	9.2	17.4
77	16.0	11.2	16.8	10.8	77	9.5	20.7	9.9	17.2
76	17.0	10.7	17.8	10.4	76	10.2	20.4	10.5	17.1
75	18.0	10.3	18.7	10.0	75	10.8	20.1	11.2	16.9
73	19.9	9.6	20.6	9.3	73	12.1	19.6	12.5	16.7
70	22.7	8.6	23.3	8.4	70	14.0	18.9	14.3	16.3
68	24.4	8.0	24.8	7.9	68	15.3	18.5	15.6	16.2
65	27.0	7.3	27.6	7.2	65	17.1	18.0	17.4	15.9
63	28.7	6.9	29.2	6.8	63	18.3	17.7	18.6	15.8
60	31.1	6.3	31.6	6.3	60	19.9	16.9	20.2	15.6
58	32.7	6.0	33.1	5.8	58	21.0	16.0	21.3	15.5
55	34.8	5.1	35.1	4.9	55	22.4	14.1	22.8	13.8
53	36.2	4.6	36.4	4.5	53	23.4	13.0	23.7	12.8
50	38.1	3.9	38.3	3.8	50	24.8	11.6	25.1	11.4
48	39.5	3.6	39.5	3.4	48	25.7	10.8	25.9	10.7
45	41.3	3.1	41.3	3.0	45	27.0	9.8	27.1	9.7
43	42.4	2.8	42.4	2.7	43	27.8	9.2	27.9	9.2
40	44.0	2.4	43.9	2.3	40	29.0	8.5	29.1	8.4
38	45.0	2.1			38	29.8	8.0		
35	46.5	1.9			35	30.8	7.5		
33	47.4	1.7			33	31.4	7.1		
30	48.6	1.5			30	32.3	6.7		
28	49.3	1.3			28	32.8	6.4		
25	50.3	1.2			25	33.6	6.1		
20	51.7	1.0			20	34.6	5.7		
G			2		G			4	

C: Loaded boom angle (°)  
R: Load radius (m)  
W: Rated lifting capacity (Unit: x 1,000 kg)  
G: Number of parts of line

# GR-1450EX RATED LIFTING CAPACITIES

WITHOUT COUNTERWEIGHT ON-RUBBER STATIONARY (Unit: x 1,000 kg)												
A \ B	Over front and rear						360° Rotation					
	13.1 m		17.4 m		21.8 m		13.1 m		17.4 m		21.8 m	
	C		C		C		C		C		C	
2.50	73	10.0	78	10.0	80	10.0	73	10.0	78	10.0	80	10.0
3.00	71	10.0	76	10.0	79	10.0	71	10.0	76	10.0	79	10.0
3.50	68	10.0	74	10.0	78	10.0	68	9.9	74	10.0	78	10.0
4.00	66	10.0	72	10.0	76	10.0	66	8.0	72	9.7	76	10.0
4.50	63	10.0	71	10.0	75	10.0	63	6.4	71	8.1	75	9.0
5.00	61	9.2	69	10.0	74	10.0	61	5.1	69	6.8	74	7.7
5.50	58	8.0	67	9.5	72	10.0	58	4.0	67	5.7	72	6.6
6.00	55	6.9	65	8.4	71	9.1	55	3.0	65	4.7	71	5.6
6.50	52	5.9	63	7.4	69	8.1	52	2.1	63	3.9	69	4.8
7.00	49	5.1	61	6.5	68	7.4			61	3.1	68	4.1
7.50	46	4.3	59	5.8	67	6.6			59	2.4	67	3.3
8.00	43	3.3	57	5.1	65	5.9			57	1.7	65	2.7
9.00	35	1.8	53	3.7	62	4.6					62	1.7
10.00			49	2.4	59	3.4						
11.00			44	1.5	56	2.4						
12.00					52	1.7						
D	0		40		50		47		56		59	
Telescoping conditions (%)												
Tele. 1	0		0		0		0		0		0	
Tele. 2	0		0		0		0		0		0	
Tele. 3	0		0		0		0		0		0	
Tele. 4	0		0		0		0		0		0	
Tele. 5	0		45		90		0		45		90	
E	4		4		4		4		4		4	

A: Boom length (m)  
 B: Load radius (m)  
 C: Loaded boom angle (°)  
 D: Minimum boom angle (°)  
 for indicated length (no load)  
 E: Number of parts of line

NOTE: The lifting capacity data stowed in the AUTOMATIC MOMENT LIMITER (AML-C) is based on the standard number of parts of line listed in the chart. Standard number of parts of line for on-rubber operation should be according to the chart.

## WARNING AND OPERATING INSTRUCTIONS FOR ON RUBBER LIFTING CAPACITIES

- Rated lifting capacities shown in the table are based on condition that crane is set on firm level surface, with suspension lock applied. Those above thick lines are based on tire capacity and those below, on crane stability. They are based on actual load radius increased by tire deformation and boom deflection.
- Rated lifting capacities based on crane stability are according to ISO4305.
- The mass of the hook (1,080 kg for 100 t capacity, 610 kg for 45 t capacity, 300 kg for 7.2 t capacity), slings and all similarly used load handling devices must be considered as part of the load and must be deducted from the lifting capacities.
- For rated lifting capacity of single top, reduce the rated lifting capacities of relevant boom according to weight reductions for auxiliary load handling equipment. Capacities of single top shall not exceed 7,200 kg including main hook.
- On-rubber lifting with "jib" is not permitted. Maximum permissible boom length is 21.8 m.
- Tires should be inflated to their correct air pressure of 650 kPa.
- Standard number of parts of line for on-rubber operation should be according to the following table.  
 Load per line should not surpass 70.6 kN {7,200 kgf} for main winch and auxiliary winch.

Boom length	13.1 m	17.4 m	21.8 m
Telescoping conditions (%)			
Tele.1	0	0	0
Tele.2	0	0	0
Tele.3	0	0	0
Tele.4	0	0	0
Tele.5	0	45	90
Number of parts of line	4	4	4

The lifting capacity data stowed in the AUTOMATIC MOMENT LIMITER (AML) is based on the standard number of parts of line listed in the chart. Maximum lifting capacity is restricted by the number of parts of line of AUTOMATIC MOMENT LIMITER (AML).

### Working area

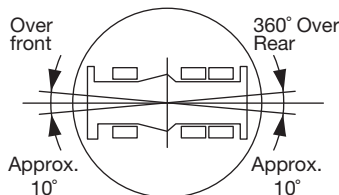

Over front and rear operation shall be performed within 10 degrees.



# WARNING AND OPERATING INSTRUCTIONS FOR LIFTING CAPACITIES

## GENERAL

1. RATED LIFTING CAPACITIES apply only to the machine as originally manufactured and normally equipped by TADANO LTD. Modifications to the machine or use of optional equipment other than that specified can result in a reduction of capacity.
2. Hydraulic cranes can be hazardous if improperly operated or maintained. Operation and maintenance of this machine must be in compliance with information, in the Operation and Maintenance Manual supplied with the crane. If this manual is missing, order a replacement through the distributor.

## SET UP

1. Rated lifting capacities on the chart are the maximum allowable crane capacities and are based on the machine standing level on firm supporting surface under ideal job conditions. Depending on the nature of the supporting surface, it may be necessary to have structural supports under the outrigger floats or tires to spread the loads to a larger bearing surface.
2. For outrigger operation, outriggers shall be properly extended with tires free of supporting surface before operating crane.

## OPERATION

1. Rated lifting capacities based on crane stability are according to ISO 4305.
2. Rated lifting capacities above thick lines in the chart are based on crane strength and those below, on its stability. They are based on actual load radius increased by boom deflection.
3. The weight of handling device such as hook blocks (1,080 kg for 100 t capacity, 610 kg for 45 t capacity, 300 kg for 7.2 t capacity), slings, etc., must be considered as part of the load and must be deducted from the lifting capacities.
4. Rated lifting capacities are based on freely suspended loads and make no allowance for such factors as the effect of wind, sudden stopping of loads, supporting surface conditions, inflation of tires, operating speeds, side loads, etc. Side pull on the boom or jib is extremely dangerous. Such action can damage the boom, jib or swing mechanism, and lead to overturning of the crane.
5. Rated lifting capacities do not account for wind on lifted load or boom. We recommend against working under the condition that the load is out of control due to a strong wind. During boom lift, consider that the rated lifting capacity is reduced by 50% when the wind speed is 9 m/s to 12 m/s; reduced by 70% when the wind speed is 12 m/s to 14 m/s. If the wind speed is 14 m/s or over, stop operation. During jib lift, stop operation if the wind speed is 9 m/s or over.
6. Rated lifting capacities at load radius shall not be exceeded. Do not tip the crane to determine allowable loads.
7. Do not operate at boom lengths, radii, or boom angle, where no capacities are shown. Crane may overturn without any load on the hook.
8. When boom length is between values listed, refer to the rated lifting capacities of the next longer and next shorter booms for the same radius. The lesser of the two rated lifting capacities shall be used.
9. When making lifts at a load radius not shown, use the next longer radius to determine allowable capacity.
10. Load per line should not exceed 7,200 kg for main winch and auxiliary winch.

11. Check the actual number of parts of line with AUTOMATIC MOMENT LIMITER (AML-C) before operation. Maximum lifting capacity is restricted by the number of parts of line of AUTOMATIC MOMENT LIMITER (AML-C). Limited capacity is as determined from the formula, Single line pull for main winch  $7,200 \text{ kg} \times \text{number of parts of line}$ .
12. The boom angle before loading should be greater to account for deflection. For rated lifting capacities, the loaded boom angle and the load radius is for reference only.
13. Maximum capacity without boom pin is shown in the chart.
14. Do not operate extension or retraction of the boom with loads.
15. For lifting capacity of single top, deduct the weight of the load handling equipment from the rated lifting capacity of the boom. For the lifting capacity of single top, the net capacity shall not exceed 7,200 kg including main boom hook mass attached to the boom.
16. When the base jib or top jib or both jibs are removed, set the jib status switch to the DISMOUNTED position.
17. When erecting and stowing jib, be sure to retain it by hand or by other means to prevent its free movement.
18. Use "ANTI-TWO-BLOCK" disable switch when erecting and stowing jib and when stowing hook block. While the switch is pushed, the hoist does not stop, even when overwind condition occurs.
19. For selected boom length or less with jib, rated lifting capacities are determined by loaded boom angle only in the column headed "selected boom + jib".
20. The boom extending operation and lowering operation are prohibited during lifting a load with multiple line lift. When lifting a load by using jib (aux.winch) and boom (main winch) simultaneously, do the following:
  - Enter the operation status as jib operation, not as boom operation.
  - Before starting operation, make sure that the mass of a load is within the rated lifting capacity for the jib. (The AML display indicates inaccurate working radius and actual load values during multiple line lift.)
 When lifting a load by using single top (aux.winch) and boom (main winch) simultaneously, do the following:
  - Enter the operation status as single top operation, not as boom operation.
  - Before starting operation, make sure that the mass of a load is within the rated lifting capacity for the single top. (The AML display indicates inaccurate working radius and actual load values during multiple line lift.)
21. Outriggers shall be extended 8.2 m spread when installing or removing removable counterweight.

## DEFINITIONS

1. Load Radius: Horizontal distance from a projection of the axis of rotation to supporting surface before loading to the center of the vertical hoist line or tackle with load applied.
2. Loaded Boom Angle: The angle between the boom base section and the horizontal, after lifting the rated lifting capacity at the load radius.
3. Working Area: Area measured in a circular arc about the centerline of rotation.
4. Freely Suspended Load: Load hanging free with no direct external force applied except by the hoist line.
5. Side Load: Horizontal side force applied to the lifted load either on the ground or in the air.

# WARNING AND OPERATING INSTRUCTIONS FOR USING THE AUTOMATIC MOMENT LIMITER (AML-C)

1. Set AML select keys in accordance with the actually operating crane conditions and don't fail to make sure, before crane operation, that the displays on front panel are correct.
2. When operating crane on outriggers:
  - Set P.T.O. switch to "ON".
  - Press the outrigger state select key to register for the outrigger operation. If the display agrees with the actual state, press the set key to register. After the completion of the registration, the pop-up window closes.
  - Press the lift state select key to register the lift state to be used (single top / jib / boom).
  - Each time the lift state select key is pressed, the display changes. If the display agrees with the actual state, press the set key to register. After the completion of the registration, the pop-up window closes.
  - When erecting and stowing jib, select the status of jib set (Jib lift indicator symbol flickers).
3. When operating crane on rubber:
  - Set P.T.O. switch to "ON".
  - Press the outrigger state select key to register for the on rubber operation. Each time the outrigger state select key is pressed, the display changes. Select the stationary operation, the on rubber state indicative symbol flickers.
  - Press the lift state select key to register the lift state.

However, pay attention to the following.  
For stationary operation.

  - The front and rear capacities are attainable only when the over front or rear position. The front capacities are attainable only when the over front position symbol comes on. When the boom is more than 2 degrees from centered over front of chassis, 360° capacities are in effect.
- When a load is lifted in the front or rear position and then swung to the side area, make sure the value of the AUTOMATIC MOMENT LIMITER (AML-C) is below the 360° lifting capacity.
4. This machine is equipped with an automatic slewing stop device. (For the details, see Operation and Maintenance Manual.) But, operate very carefully because the automatic slewing stop does not work in the following case.
  - During on-rubber operation.
5. During crane operation, make sure that the displays on front panel are in accordance with actual operating conditions.
6. The displayed values of AUTOMATIC MOMENT LIMITER (AML-C) are based on freely suspended loads and make no allowance for such factors as the effect of wind, sudden stopping of loads, supporting surface conditions, inflation of tire, operating speed, side loads, etc.  
For safe operation, it is recommended when extending and lowering boom or slewing, lifting loads shall be appropriately reduced.
7. AUTOMATIC MOMENT LIMITER (AML-C) is intended as an aid to the operator. Under no condition should it be relied upon to replace use of capacity charts and operating instruction. Sole reliance upon AUTOMATIC MOMENT LIMITER (AML-C) aids in place of good operating practice can cause an accident. The operator must exercise caution to assure safety.

## GR-1450EX Axle weight distribution chart

Manual offset jib	Kilograms			
	GVW	1st	2nd	3rd
Basic machine	90,805	28,701	30,814	31,290
Remove: 1. 7.2 ton hook block	-300	-421	61	61
2. 100 ton hook block	-1,080	-1,771	346	346
3. Counterweight 11,100 kg	-11,120	3,351	-7,236	-7,236
4. Counterweight 18,200 kg	-18,160	5,473	-11,816	-11,816
5. Front and rear outrigger boxes and beams	-8,962	-3,463	-2,750	-2,750
6. Auxiliary Winch & wire rope	-1,202	490	-846	-846
7. Boom and Jib	-17,074	-21,845	2,386	2,386







**TADANO**

**TADANO LTD.** (International Sales Division)

KANDA SQUARE 18th Floor,  
2-2-1 Kanda-Nishikicho,  
Chiyoda-ku, Tokyo 101-0054, Japan

Phone : +81-3-6811-7309

[URL](http://www.tadano.com) www.tadano.com

[E-mail](mailto:info@tadano.com) info@tadano.com

Printed in Japan  
2022-11-1