

GR-900EX-4

(Left-hand drive)
90 Ton Capacity

SPEC. SHEET NO. GR-900E-4-00102/R-01

HYDRAULIC ROUGH TERRAIN CRANE

DIMENSIONS

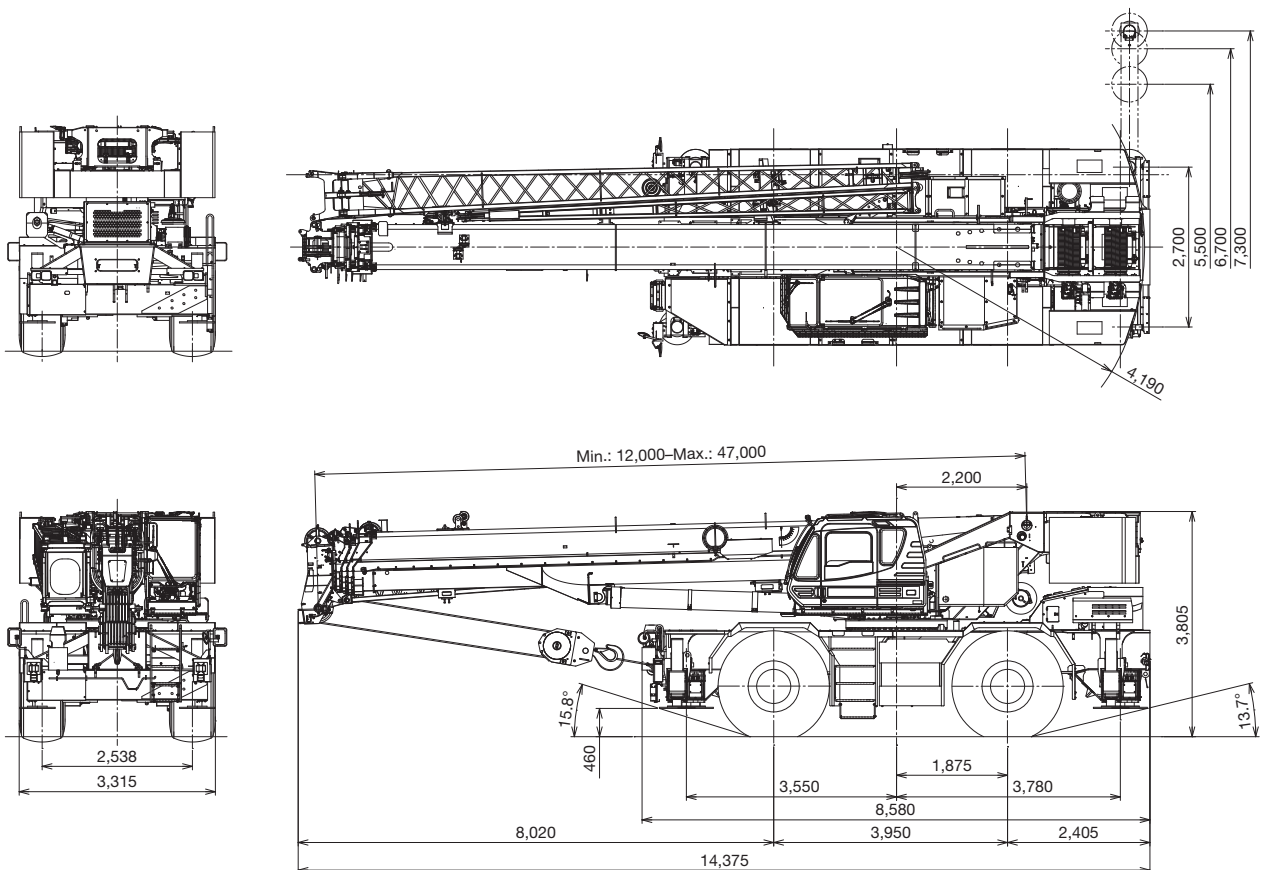

Note : Dimension is with boom angle at -1.5 degree.

GENERAL DIMENSIONS

Turning radius (29.5-25)		Overall length	approx. 14,375 mm
4 wheel steer	6.8 m	Overall width	approx. 3,315 mm
2 wheel steer	10.9 m	Overall height	approx. 3,805 mm

CRANE SPECIFICATIONS

BOOM

5 section full power partially synchronized telescoping boom of round box construction with 7 sheaves at boom head. The synchronization system consists of 2 telescope cylinders, extension cables and retraction cables. Hydraulic cylinder fitted with holding valve. 2 easily removable wire rope guards, rope dead end provided on both sides of boom head. Boom telescope sections are supported by wear pads both vertically and horizontally.

Fully retracted length.....	12.0 m
Fully extended length	47.0 m
Extension speed.....	35.0 m in 155 s
Root diameter.....	0.44 m

BOOM ELEVATION

By a double acting hydraulic cylinder with holding valve. Combination controls for hand or foot operation. Boom angle indicator.

Automatic speed reduction and slow stop function.

Boom angle	-1.5°- 80.5°
Boom raising speed	20° to 60° in 46 s

JIB (option)

2 stage swing around boom extension with triple offset (tilt type). Single sheave at jib head.

Stows alongside base boom section.

Length	10.1 m, 17.7 m
Offset.....	3.5°, 25°, 45°
Root diameter.....	0.396 m

AUXILIARY LIFTING SHEAVE (SINGLE TOP)

Single sheave mounted to main boom head for single line work(stowable).

Root diameter.....	0.396 m
--------------------	---------

ANTI-TWO-BLOCK DEVICE

Pendant type over-winding cut out device with audio-visual (FAILURE lamp/BUZZER) warning system.

SLEWING

Hydraulic axial piston motor driven through planetary slewing speed reducer. Continuous 360° full circle slewing on ball bearing.

Equipped with manually locked/released slewing brake. A positive slewing lock for pick and carry and travel modes, manually engaged in cab. Twin slewing system : Free slewing or lock slewing controlled by selector switch on front console.

Slewing speed	1.5 min ⁻¹ {rpm}
---------------------	-----------------------------

WINCH

MAIN WINCH

Variable speed type with grooved drum driven by hydraulic axial piston motor through speed reducer. Power load lowering and raising.

Equipped with automatic brake (neutral brake) and counterbalance valve. Controlled independently of auxiliary winch. Equipped with cable follower and drum rotation indicator.

MAIN DRUM

Root diameter x wide	0.362 m x 0.681 m
Wire rope diameter x length	19 mm x 253 m
Drum capacity	346 m, 7 layers
Maximum single line pull (1st layer).....	89.1 kN (9,090 kgf)
Maximum permissible linepull wire strength.....	64.7 kN (6,600 kgf)

AUXILIARY WINCH

Variable speed type with grooved drum driven by hydraulic axial piston motor through speed reducer. Power load lowering and raising.

Equipped with automatic brake (neutral brake) and counterbalance valve. Controlled independently of main winch. Equipped with cable follower and drum rotation indicator.

AUXILIARY DRUM

Root diameter x wide	0.362 m x 0.681 m
Wire rope diameter x length	19 mm x 139 m
Drum capacity	346 m, 7 layers
Maximum single line pull (1st layer).....	89.1 kN (9,090 kgf)
Maximum permissible linepull wire strength	64.7 kN (6,600 kgf)

WIRE ROPE

Non-rotating wire (no-spin), extra improved plow steel, preformed, independent wire rope core, right regular lay.

Main & Auxillary	19 mm
------------------------	-------

HOOK BLOCKS

90 ton (option)	8 sheaves with swivel hook and safety latch
50 ton (option)	5 sheaves with swivel hook and safety latch
35 ton (option)	3 sheaves with swivel hook and safety latch
6.6 ton	Weighted hook with swivel and safety latch

COUNTERWEIGHT

Integral with slewing frame, Mass	9,800 kg
---	----------

HYDRAULIC SYSTEM

PUMPS

2 variable piston pumps for crane functions. Tandem gear pump for steering, slewing and other hydraulic systems.

Powered by carrier engine. Pump disconnect for crane is engaged/disengaged by rotary switch from operator's cab.

CONTROL VALVES

Multiple valves actuated by pilot pressure with integral pressure relief valves.

RESERVOIR

795 liters capacity. External sight level gauge.

FILTRATION

BETA10=10 return filter, full flow with bypass protection, located inside of hydraulic reservoir. Accessible for easy replacement.

OIL COOLER - Air cooled fan type.

CAB AND CONTROLS

Both crane and drive operations can be performed from one cab mounted on rotating superstructure.

20° tilt, left side, 1 man type, steel construction with sliding door access and safety glass windows opening at side. Door window is powered control. Windshield glass window and roof glass window are shatter-resistant. Wiper and washer (front windshield and roof window). Tinted safety glass and sun visor. Tilt-telescoping steering wheel. Adjustable control lever stands for slewing, boom elevating, boom telescoping, auxiliary winch and main winch. Control lever stands can change neutral positions and tilt for easy access to cab. Foot operated controls: boom elevating, boom telescoping, service brake and engine throttle. 3 way adjustable operator's seat with high back, headrest and armrest. Cab floor mat. Engine throttle knob. Hot water cab heater and air conditioning.

Dash-mounted Instrument panel, Multifunction Display, Starter switch (engine start / stop), 12 V power outlet, USB port, drive selector switch, parking brake switch, steering mode select switch, power window switch, pump engaged/disengaged switch, slewing brake switch, boom telescoping/auxiliary winch select switch, outrigger control panel, free slewing/lock slewing selector switch and air conditioning control switch.

Instruments panel - Torque converter oil temperature, engine water temperature, air pressure, fuel, speedometer, tachometer, hour meter and odometer/tripmeter.

Multi function display - Fuel consumption monitor.

CRANE SPECIFICATIONS

TADANO Automatic Moment Limiter (AML-E2) including:

- Control lever lockout function with audible and visual pre-warning
- Number of parts of line
- Boom position indicator
- Outrigger state indicator
- Slewing angle
- Boom angle / boom length / jib offset angle / jib length / load radius / rated lifting capacities / actual loads read out
- Potential lifting height
- Ratio of actual load moment to rated load moment indication
- Permissible load
- Automatic Speed Reduction and Slow Stop function on boom elevation and slewing
- Working condition register switch
- Load radius / boom angle / tip height / slewing range preset function
- External warning lamp
- Tare function
- Main hydraulic oil pressure

- Fuel consumption monitor
- Main winch / auxiliary winch select
- Drum rotation indicator (visible type) main and auxiliary winch
- On-rubber indicator

TADANO AML-E2 monitors outrigger extended length and automatically programs the corresponding "RATED LIFTING CAPACITIES" table

Operator's right hand console includes transmission gear selector, slewing lock lever and sight level bubble.

Upper right console includes roof washer and wiper switch, emergency outrigger set up key switch, jib status switch (option), high speed winch (main / aux) switch, cab tilt switch, automatic pump disconnect enable switch, boom emergency telescoping switch (2nd and 3rd-top)

NOTE: Each crane motion speed is based on unladen conditions.

CARRIER SPECIFICATIONS

TYPE

Rear engine, left-hand drive, driving axle 2-way selected type by manual switch, 4x2 front drive, 4x4 front and rear drive.

FRAME

High tensile steel, all welded mono-box construction.

ENGINE

Model	MITSUBISHI 6M60-TLU3R [ECE-R96-02]
Type	Direct injection diesel
No. of cylinders	6
Combustion	4 cycle, turbo charged and after cooled
Bore x Stroke, mm	118 x 115
Displacement, liters	7.54
Air inlet heater	24 volt preheat
Air cleaner	Dry type, replaceable element
Oil filter	Full flow with replaceable element
Fuel filter	Full flow with replaceable element
Fuel tank, liters	300, right side of carrier
Cooling	Liquid pressurized, recirculating by-pass
Radiator	Fin and tube core, thermostat controlled
Fan, mm	Suction type, 6-blade, 600 dia.
Starting	24 volt
Charging	24 volt system, negative ground
Battery	2-120 amp. Hour
Compressor, air, l /min	830 at 2,600 min ⁻¹
Output, Max. kW (HP)	Gross 200 (267) at 2,600 min ⁻¹
Torque, Max. N·m	785 at 1,400 min ⁻¹
Capacity, liters	
Cooling water	13
Lubrication	13-15
Fuel	300

TRANSMISSION

Electronically controlled full automatic transmission.
Torque converter driving full powershift with driving axle selector.
6 forward and 2 reverse speeds, constant mesh.
3 speeds - high range - 2-wheel drive; 4-wheel drive
3 speeds - low range - 4-wheel drive

TRAVEL SPEED - 36 km/h

GRADEABILITY (tan θ) - 94% (at stall), 30%*

* Machine should be operated within the limit of engine crankcase design (17°: MITSUBISHI 6M60-TLU3R)

AXLE

Front: Full floating type, steering and driving axle with planetary reduction.

Rear: Full floating type, steering and driving axle with planetary reduction and non-spin rear differential.

STEERING

Hydraulic power steering controlled by steering wheel.

4 steering modes available: 2 wheel front, 2 wheel rear, 4 wheel coordinated and 4 wheel crab.

SUSPENSION

Front: Rigid mounted to the frame.

Rear: Pivot mounted with hydraulic lockout device.

BRAKE SYSTEMS

Service: Air over hydraulic disc brakes on all 4 wheels.

Parking/Emergency: Spring applied-air released brake acting on input shaft of front axle.

Auxiliary: Electro-pneumatic operated exhaust brake.

TIRES - 29.5-25 36PR (OR) Air pressure: 470 kPa
29.5-25 40PR (OR) Air pressure: 465 kPa

OUTRIGGERS

4 hydraulic, beam and jack outriggers.

Vertical jack cylinders equipped with integral holding valve. Each outrigger beam and jack is controlled independently from cab. Beams extend to 7.3 m center-line and retract to within 3.315 m overall width with floats. Outrigger jack floats are attached thus eliminating the need of manually attaching and detaching them. Controls and sight bubble located in superstructure cab. 4 outrigger extension lengths are provided with corresponding "RATED LIFTING CAPACITIES" for crane duty in confined areas.

Min. Extension	2.7 m center to center
Mid. Extension	5.5 m center to center
Mid. Extension	6.7 m center to center
Max. Extension	7.3 m center to center
Float size (Diameter)	0.6 m

STANDARD EQUIPMENT

- Telematics (machine data logging and monitoring system) with - HELLO-NET via internet (availability depends on countries)
- Eco mode system
- Positive control
- Over unwinding prevention
- Emergency steering system
- Transmission neutral position engine start
- Overshift prevention
- Parking braked travel warning
- Tilt-telescope steering wheel
- Halogen head lamp
- Fenders
- Battery disconnect
- 20° tilt cab
- Cup holder
- 12 V power outlet
- LED working lights
- USB port
- Air dryer
- Water separator with filter (high filtration)
- Air cleaner dust indicator
- Full instrumentation package
- Complete highway light package
- Tire inflation kit
- Towing hooks-Front and rear
- Lifting eyes
- Hook block tie down (front bumper)
- Weighted hook storage compartment
- Winch drum camera with light
- Tool storage compartment
- Automatic pump disconnect
- Hook block-6.6 t capacity (Weighted hook, swivel type with safety latch. Mass: approx. 165 kg)

OPTIONAL EQUIPMENT

- JIB (10.1m or 17.7m - 2 stage swing around boom extension)
- Preparation for JIB (storage and programming)
- Hook block-90 t capacity (8 sheaves, swivel type with safty latch. Mass: approx. 850 kg)
- Hook block-50 t capacity (5 sheaves, swivel type with safty latch. Mass: approx. 500 kg)
- Hook block-35 t capacity (3 sheaves, swivel type with safty latch. Mass: approx. 450 kg)
- Wind speed indicator
- Beacon lamp
- Radiator cover
- Outrigger control box
- Air heater
- Engine coolant heater

HOISTING PERFORMANCE

LINE SPEEDS AND PULLS

Layer	Main or auxiliary winch - 0.362 m drum			
	Line speeds ¹		Line pulls Available ²	
	m/min		kN (kgf)	
	Low	High	Low	High
1st	84	118	89.1 (9,090)	63.9 (6,520)
2nd	92	128	80.7 (8,230)	57.8 (5,900)
3rd	99	139	73.7 (7,520)	52.8 (5,390)
4th	107	149	67.8 (6,920)	48.6 (4,960)
5th	115	160	62.8 (6,410)	45.1 (4,600)
6th	122	170	58.5 (5,970)	41.9 (4,280)
7th ³	130	181	54.8 (5,590)	39.3 (4,010)

- Maximum permissible line pull wire strength.
Main & Auxiliary: 64.7 kN (6,600 kgf).

- ¹ Line speed based only on hook block, not loaded.
² Developed by machinery with each layer of wire rope, but not based on rope strength or other limitations in machinery or equipment.
³ Seventh layer of wire rope are not recommended for hoisting operations.

DRUM WIRE ROPE CAPACITIES

Wire rope layer	Main and auxiliary drum grooved lagging	
	19 mm wire rope	
	Rope per layer	Total wire rope
	m	m
1	39.0	39.0
2	42.5	81.5
3	46.0	127.5
4	49.4	176.9
5	53.0	229.9
6	56.5	286.4
7	60.0	346.4

DRUM DIMENSIONS

Root diameter	362 mm
Length	681 mm
Flange diameter	657 mm

GR-900EX-4 WORKING RANGE CHART

360° ROTATION

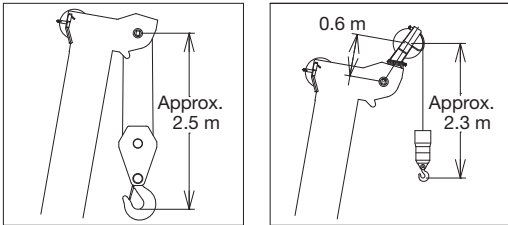
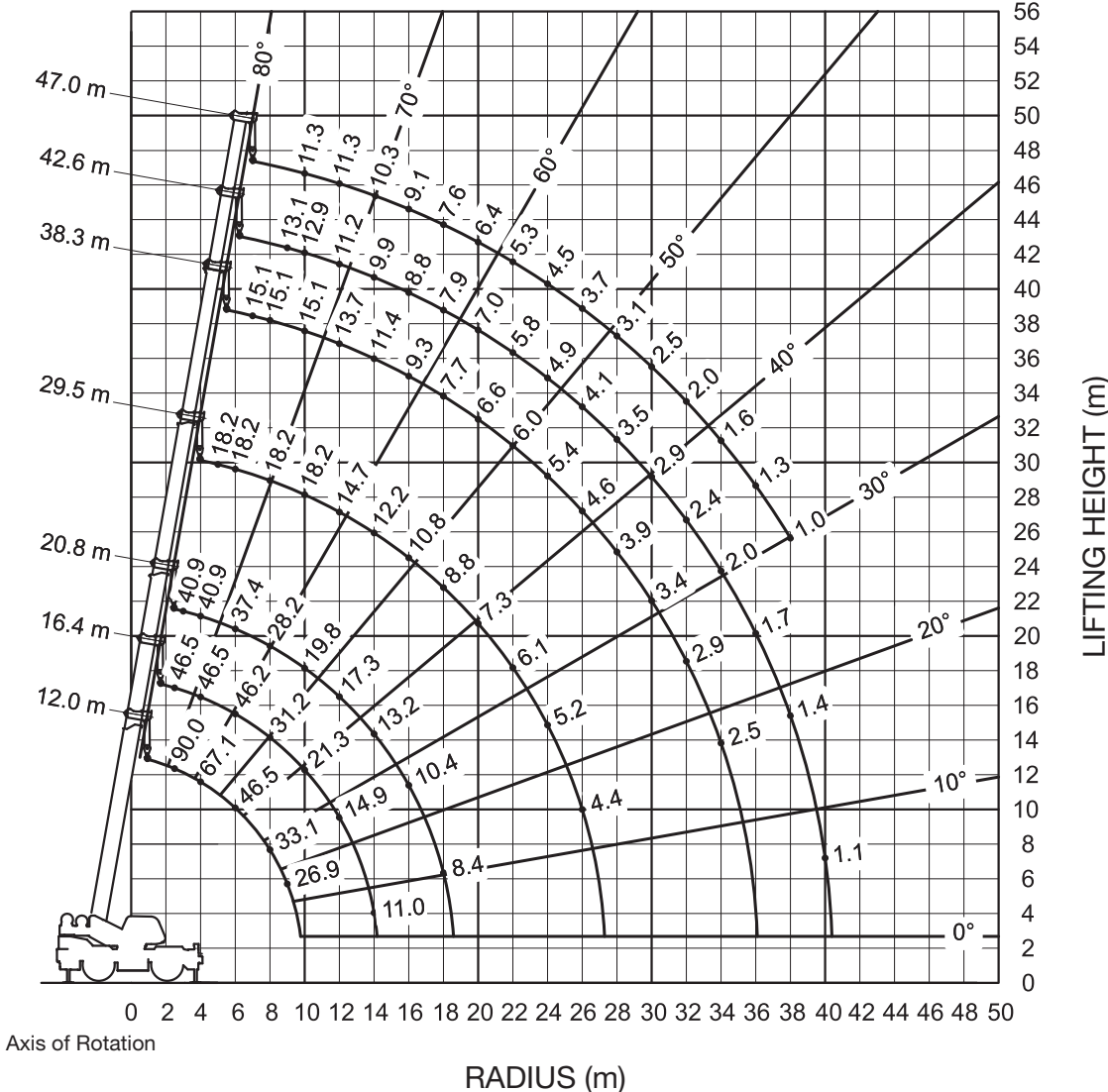

NOTE: 1. Boom geometry shown is for unloaded condition and machine standing level on firm supporting surface. Boom deflection and subsequent radius and boom angle change must be accounted for when applying load to hook.
 2. When boom length is same as telescoping mode 1 and 2, it show large load.

GR-900EX-4 WORKING RANGE CHART

SMART CHART

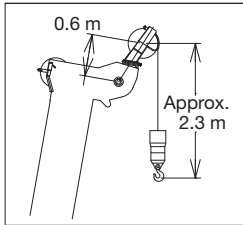
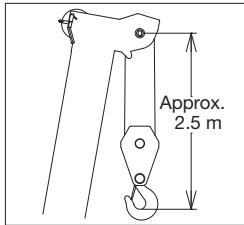
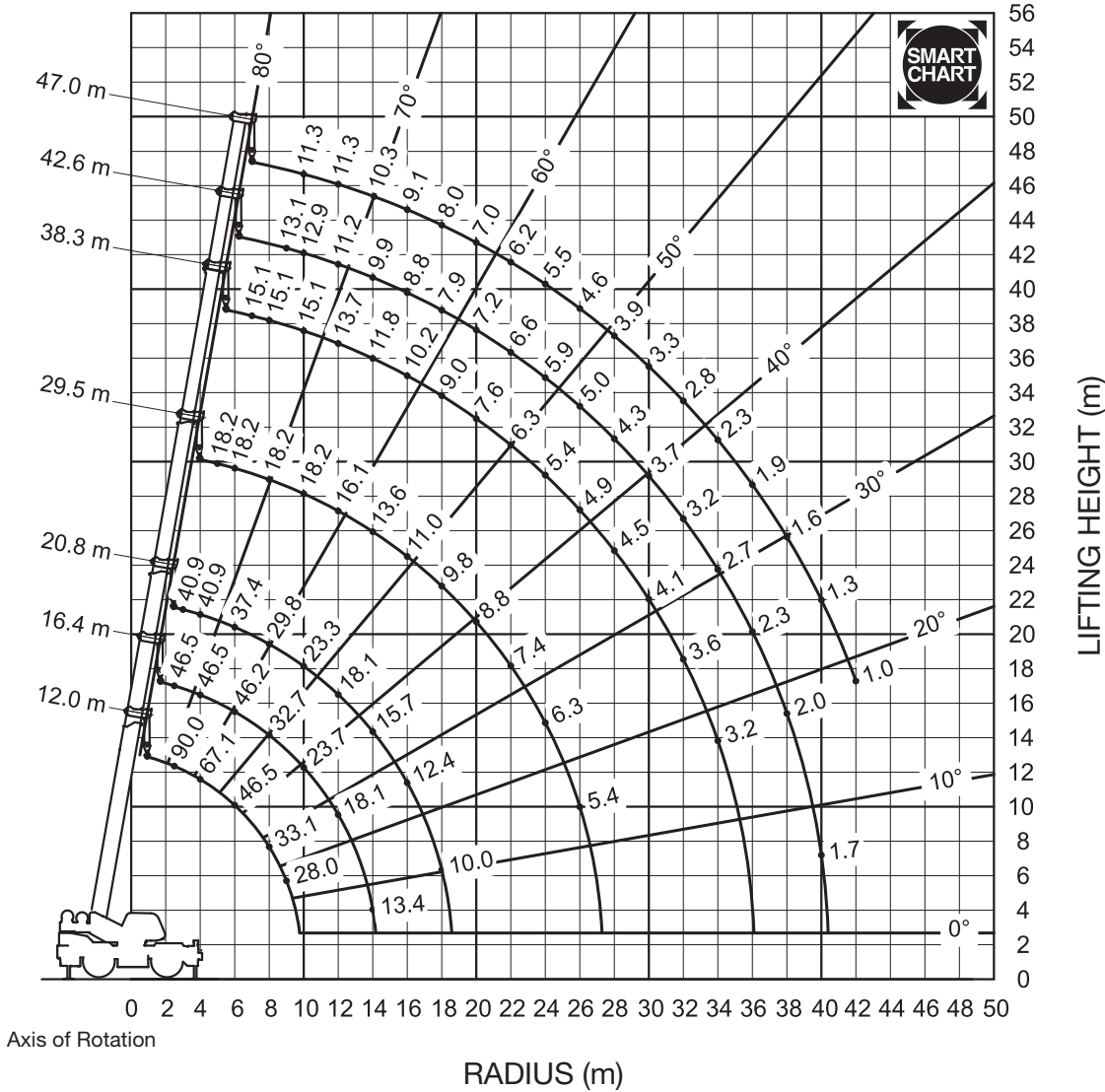

NOTE: 1. Boom geometry shown is for unloaded condition and machine standing level on firm supporting surface. Boom deflection and subsequent radius and boom angle change must be accounted for when applying load to hook.
 2. When boom length is same as telescoping mode 1 and 2, it show large load.

GR-900EX-4 WORKING RANGE CHART

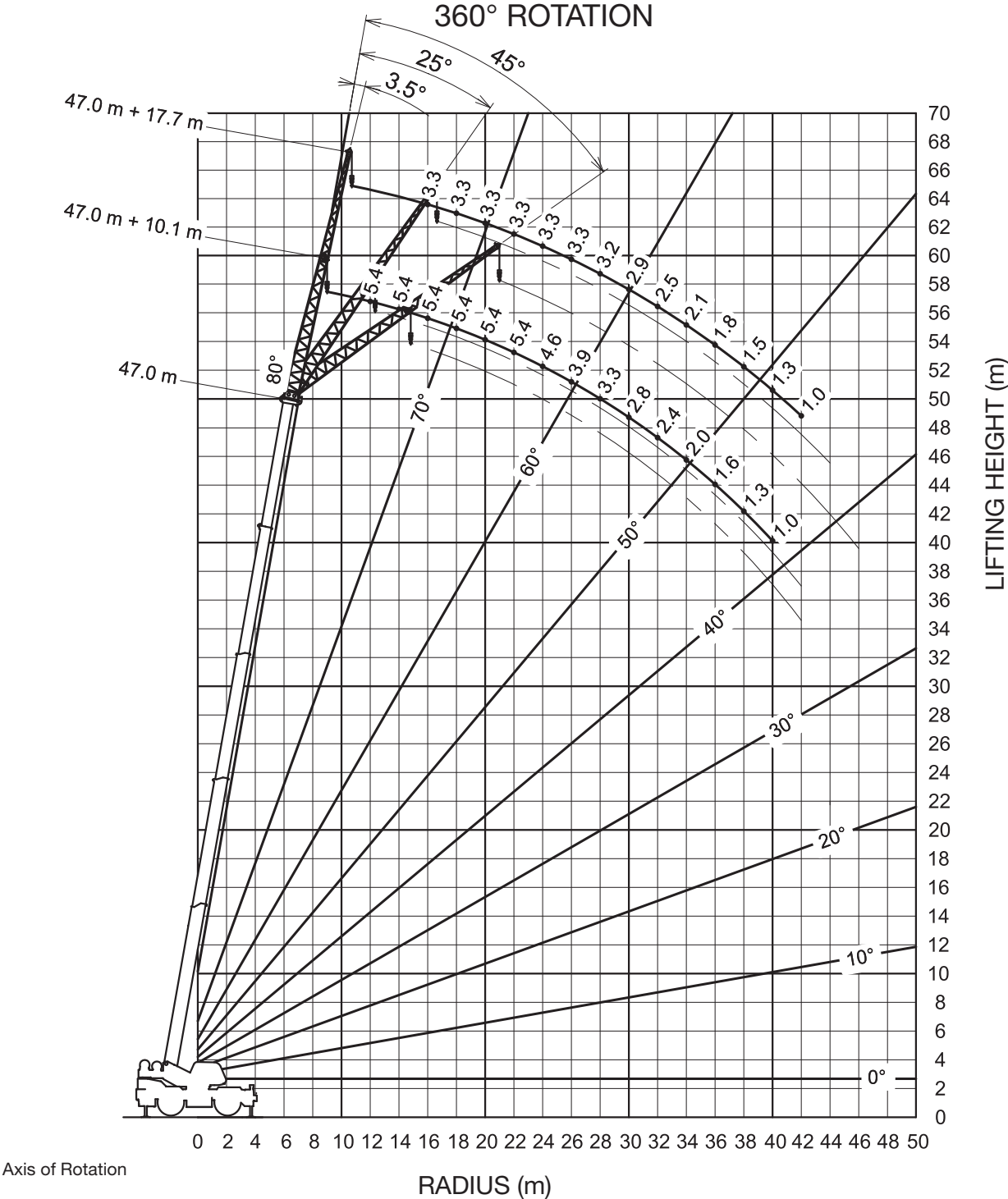

NOTE: 1. Jib geometry shown is for unloaded condition and machine standing level on firm supporting surface. Boom deflection and subsequent radius and boom angle change must be accounted for when applying load to hook.

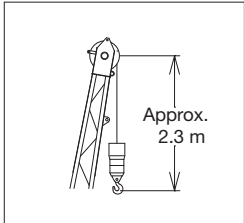

GR-900EX-4 WORKING RANGE CHART

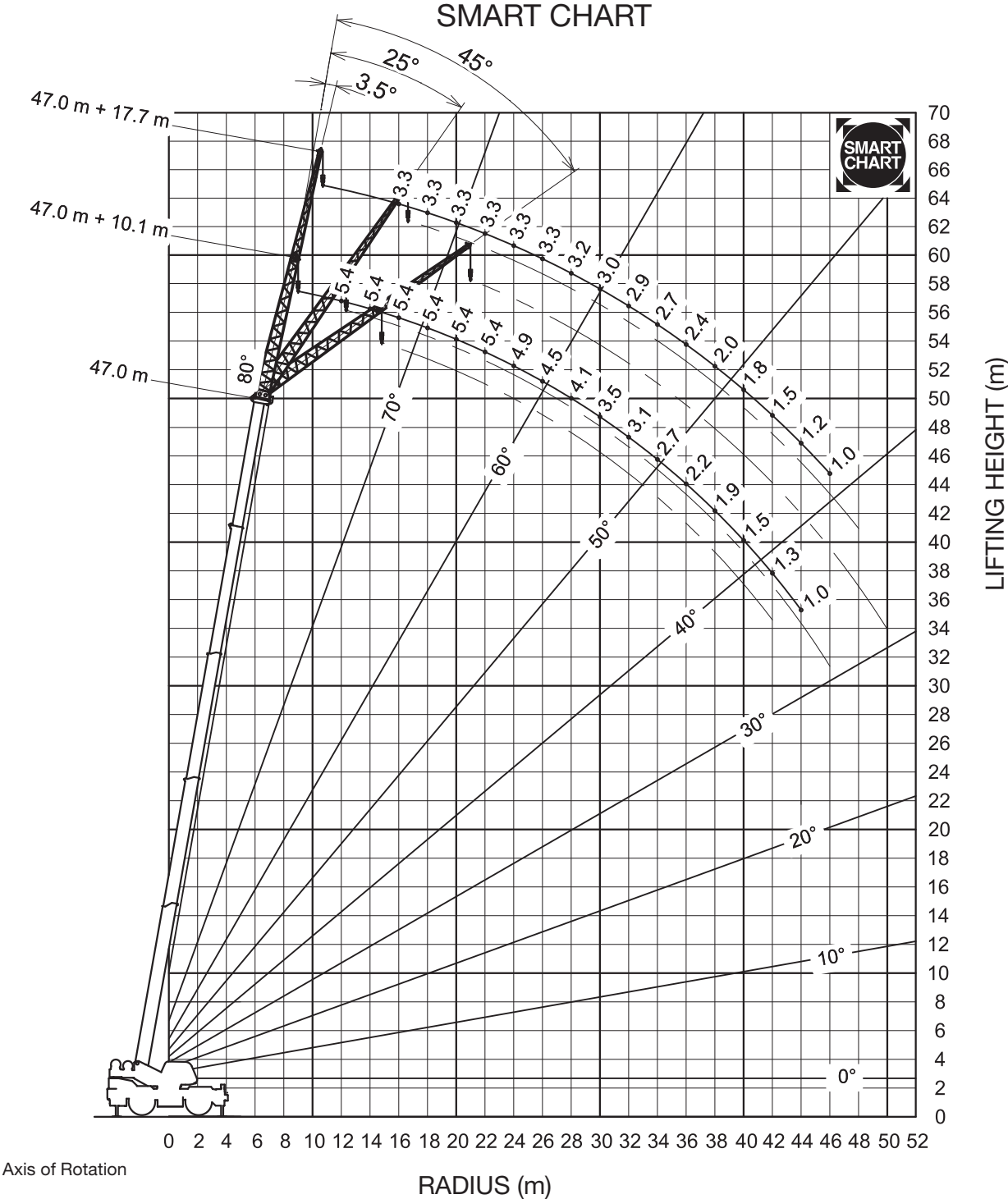

NOTE: 1. Jib geometry shown is for unloaded condition and machine standing level on firm supporting surface.
 Boom deflection and subsequent radius and boom angle change must be accounted for when applying load to hook.

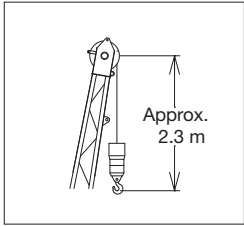

GR-900EX-4 RATED LIFTING CAPACITIES

ON OUTRIGGERS FULLY EXTENDED 7.3 m SPREAD 360° ROTATION								(Unit: × 1,000 kg)					
B	47 m Boom + 10.1 m JIB						B	47 m Boom + 17.7 m JIB					
	3.5° Offset		25° Offset		45° Offset			3.5° Offset		25° Offset		45° Offset	
12.0	5.40						12.0						
14.0	5.40						14.0						
16.0	5.40		5.40				16.0	3.30					
18.0	5.40		5.40		4.50		18.0	3.30					
20.0	5.40		5.30		4.40		20.0	3.30					
22.0	5.40		4.80		4.30		22.0	3.30		2.70			
24.0	4.60		4.50		4.20		24.0	3.30		2.60			
26.0	3.90		4.10		3.90		26.0	3.30		2.50		2.30	
28.0	3.30		3.70		3.70		28.0	3.20		2.50		2.20	
30.0	2.80		3.20		3.40		30.0	2.90		2.40		2.20	
32.0	2.40		2.70		2.90		32.0	2.50		2.30		2.10	
34.0	2.00		2.30		2.50		34.0	2.10		2.30		2.10	
36.0	1.60		1.90		2.00		36.0	1.80		2.20		2.00	
38.0	1.30		1.50		1.70		38.0	1.50		1.90		2.00	
40.0	1.00		1.20		1.30		40.0	1.30		1.60		1.90	
42.0			0.90		1.00		42.0	1.00		1.40		1.60	
44.0							44.0			1.10		1.30	
46.0							46.0					1.00	
Telescoping mode	1, 2		1, 2		1, 2		Telescoping mode	1, 2		1, 2		1, 2	

ON OUTRIGGERS FULLY EXTENDED 7.3 m SPREAD 360° ROTATION								(Unit: × 1,000 kg)					
B	42.6 m Boom + 10.1 m JIB						B	42.6 m Boom + 17.7 m JIB					
	3.5° Offset		25° Offset		45° Offset			3.5° Offset		25° Offset		45° Offset	
11.0	5.90						11.0						
12.0	5.90						12.0						
14.0	5.90						14.0						
16.0	5.90		5.90				16.0	3.50					
18.0	5.90		5.60		4.50		18.0	3.50					
20.0	5.60		5.10		4.40		20.0	3.50					
22.0	5.00		4.60		4.20		22.0	3.50		2.70			
24.0	4.60		4.20		4.00		24.0	3.50		2.60		2.30	
26.0	4.20		3.90		3.80		26.0	3.30		2.50		2.20	
28.0	3.90		3.60		3.50		28.0	3.20		2.50		2.20	
30.0	3.30		3.40		3.30		30.0	3.00		2.40		2.10	
32.0	2.80		3.10		3.00		32.0	2.80		2.30		2.10	
34.0	2.40		2.60		2.80		34.0	2.60		2.20		2.00	
36.0	2.00		2.20		2.30		36.0	2.20		2.20		2.00	
38.0	1.70		1.80		1.90		38.0	1.90		2.10		1.90	
40.0	1.40		1.50				40.0	1.60		1.90		1.90	
42.0	1.10		1.20				42.0	1.30		1.60		1.80	
44.0	0.90		1.00				44.0	1.10		1.40		1.50	
46.0							46.0	0.90		1.10		1.20	
48.0							48.0			0.90			
Telescoping mode	2		2		2		Telescoping mode	2		2		2	

ON OUTRIGGERS FULLY EXTENDED 7.3 m SPREAD 360° ROTATION								(Unit: × 1,000 kg)							
B	38.3 m Boom + 10.1 m JIB						B	38.3 m Boom + 17.7 m JIB							
	3.5° Offset		25° Offset		45° Offset			3.5° Offset		25° Offset		45° Offset			
10.0	6.60	6.50					10.0								
11.0	6.60	6.50					11.0								
12.0	6.60	6.50					12.0	4.20	3.80						
14.0	6.60	6.50	6.20	6.10			14.0	4.20	3.80						
16.0	6.60	6.50	5.90	5.80	4.70	4.60	16.0	4.20	3.80						
18.0	6.60	5.80	5.60	5.30	4.50	4.50	18.0	4.20	3.80	3.10	3.00				
20.0	6.60	5.20	5.30	4.80	4.40	4.30	20.0	4.00	3.80	2.90	2.90				
22.0	5.60	4.70	5.10	4.40	4.30	4.20	22.0	3.80	3.60	2.80	2.70	2.30	2.30		
24.0	4.80	4.20	4.90	4.00	4.20	3.90	24.0	3.60	3.40	2.70	2.60	2.30	2.30	2.20	
26.0	4.10	3.90	4.50	3.70	4.10	3.60	26.0	3.40	3.30	2.60	2.50	2.20	2.20	2.10	
28.0	3.40	3.50	3.80	3.40	4.00	3.30	28.0	3.20	3.10	2.50	2.40	2.10	2.10	2.10	
30.0	2.80	3.30	3.20	3.10	3.40	3.10	30.0	3.10	2.80	2.40	2.40	2.00	2.00	2.00	
32.0	2.30	3.00	2.60	2.90	2.80	2.80	32.0	2.70	2.60	2.30	2.30	2.00	2.00	2.00	
34.0	1.90	2.80	2.20	2.70	2.30	2.60	34.0	2.30	2.40	2.30	2.20	1.90	1.90	1.90	
36.0	1.50	2.40	1.80	2.50	1.80	2.50	36.0	1.90	2.20	2.20	2.10	1.90	1.90	1.90	
38.0	1.20	2.10	1.40	2.20			38.0	1.60	2.00	2.00	2.00	1.80	1.80	1.80	
40.0	0.90	1.80	1.10	1.90			40.0	1.30	1.90	1.60	1.80	1.80	1.80	1.80	
42.0		1.50		1.60			42.0	1.00	1.70	1.30	1.70	1.50	1.50	1.70	
44.0		1.30					44.0		1.50	1.00	1.60				
46.0							46.0		1.30		1.40				
48.0							48.0		1.10		1.20				
50.0							50.0		0.90		1.00				
Telescoping mode	1	2	1	2	1	2	Telescoping mode	1	2	1	2	1	2	1	2

B: Load radius (m)

GR-900EX-4 RATED LIFTING CAPACITIES

SMART CHART		ON OUTRIGGERS FULLY EXTENDED 7.3 m SPREAD						(Unit: × 1,000 kg)	
		47 m Boom + 10.1 m JIB			47 m Boom + 17.7 m JIB				
B		3.5° Offset	25° Offset	45° Offset	B	3.5° Offset	25° Offset	45° Offset	
12.0		5.40			12.0				
14.0		5.40			14.0				
16.0		5.40	5.40		16.0	3.30			
18.0		5.40	5.40	4.50	18.0	3.30			
20.0		5.40	5.30	4.40	20.0	3.30			
22.0		5.40	4.80	4.30	22.0	3.30	2.70		
24.0		4.90	4.50	4.20	24.0	3.30	2.60		
26.0		4.50	4.10	3.90	26.0	3.30	2.50	2.30	
28.0		4.10	3.80	3.70	28.0	3.20	2.50	2.20	
30.0		3.50	3.60	3.40	30.0	3.00	2.40	2.20	
32.0		3.10	3.30	3.20	32.0	2.90	2.30	2.10	
34.0		2.70	2.90	3.00	34.0	2.70	2.30	2.10	
36.0		2.20	2.50	2.70	36.0	2.40	2.20	2.00	
38.0		1.90	2.10	2.20	38.0	2.00	2.10	2.00	
40.0		1.50	1.80	1.90	40.0	1.80	2.10	2.00	
42.0		1.30	1.40	1.50	42.0	1.50	1.90	2.00	
44.0		1.00	1.20		44.0	1.20	1.60	1.80	
46.0			0.90		46.0	1.00	1.30	1.50	
48.0					48.0		1.00	1.20	
50.0					50.0			0.90	
Telescoping mode		1, 2	1, 2	1, 2	Telescoping mode	1, 2	1, 2	1, 2	

SMART CHART		ON OUTRIGGERS FULLY EXTENDED 7.3 m SPREAD						(Unit: × 1,000 kg)	
		42.6 m Boom + 10.1 m JIB			42.6 m Boom + 17.7 m JIB				
B		3.5° Offset	25° Offset	45° Offset	B	3.5° Offset	25° Offset	45° Offset	
11.0		5.90			11.0				
12.0		5.90			12.0				
14.0		5.90			14.0				
16.0		5.90	5.90		16.0	3.50			
18.0		5.90	5.60	4.50	18.0	3.50			
20.0		5.60	5.10	4.40	20.0	3.50			
22.0		5.00	4.60	4.20	22.0	3.50	2.70		
24.0		4.60	4.20	4.00	24.0	3.50	2.60	2.30	
26.0		4.20	3.90	3.80	26.0	3.30	2.50	2.20	
28.0		3.90	3.60	3.50	28.0	3.20	2.50	2.20	
30.0		3.60	3.40	3.30	30.0	3.00	2.40	2.10	
32.0		3.30	3.10	3.00	32.0	2.80	2.30	2.10	
34.0		3.00	2.90	2.80	34.0	2.60	2.20	2.00	
36.0		2.60	2.70	2.70	36.0	2.40	2.20	2.00	
38.0		2.20	2.40	2.50	38.0	2.20	2.10	1.90	
40.0		1.90	2.10		40.0	2.10	2.00	1.90	
42.0		1.60	1.80		42.0	1.90	1.80	1.90	
44.0		1.30	1.50		44.0	1.60	1.70	1.80	
46.0		1.10	1.20		46.0	1.30	1.60	1.70	
48.0		0.90			48.0	1.10	1.30		
50.0					50.0	0.90	1.10		
52.0					52.0		0.90		
Telescoping mode		2	2	2	Telescoping mode	2	2	2	

SMART CHART		ON OUTRIGGERS FULLY EXTENDED 7.3 m SPREAD						(Unit: × 1,000 kg)	
		38.3 m Boom + 10.1 m JIB			38.3 m Boom + 17.7 m JIB				
B		3.5° Offset	25° Offset	45° Offset	B	3.5° Offset	25° Offset	45° Offset	
10.0		6.60	6.50		10.0				
11.0		6.60	6.50		11.0				
12.0		6.60	6.50		12.0	4.20	3.80		
14.0		6.60	6.50	6.20	14.0	4.20	3.80		
16.0		6.60	6.50	5.90	16.0	4.20	3.80		
18.0		6.60	5.80	5.60	18.0	4.20	3.80	3.10	
20.0		6.60	5.20	5.30	20.0	4.00	3.80	2.90	
22.0		6.60	4.70	5.10	22.0	3.80	3.60	2.80	
24.0		5.70	4.20	4.90	24.0	3.60	3.40	2.70	
26.0		4.90	3.90	4.70	26.0	3.40	3.30	2.60	
28.0		4.30	3.50	4.50	28.0	3.20	3.10	2.50	
30.0		3.60	3.30	4.00	30.0	3.10	2.80	2.40	
32.0		3.10	3.00	3.40	32.0	2.90	2.60	2.30	
34.0		2.60	2.80	2.80	34.0	2.80	2.40	2.20	
36.0		2.20	2.60	2.40	36.0	2.50	2.20	2.10	
38.0		1.80	2.40	2.00	38.0	2.10	2.00	2.00	
40.0		1.50	2.20	1.60	40.0	1.80	1.90	2.00	
42.0		1.20	2.00	1.30	42.0	1.50	1.70	1.80	
44.0		0.90	1.80		44.0	1.20	1.60	1.80	
46.0					46.0	1.00	1.50	1.60	
48.0					48.0		1.40	1.40	
50.0					50.0		1.30	1.30	
52.0					52.0		1.10		
Telescoping mode		1	2	1	Telescoping mode	1	2	1	

B: Load radius (m)

GR-900EX-4 RATED LIFTING CAPACITIES

ON RUBBER STATIONARY					(Unit: × 1,000 kg)								
Over front					360° Rotation								
B \ A	12.0		20.8		29.5		B \ A	12.0		20.8		29.5	
	B	A	B	A	B	A		B	A	B	A	B	A
3.5		30.50					3.5						
4.0		27.30					4.0		17.20				
4.5		24.60					4.5		15.00				
5.0		22.30					5.0		12.80				
5.5		20.40					5.5		10.80				
6.0		18.60		15.80			6.0		9.20		10.20		
6.5		17.10		15.80			6.5		7.90		9.10		
7.0		15.80		15.80		11.20	7.0		6.80		8.30		
7.5		14.40		14.90		11.20	7.5		5.90		7.40		7.00
8.0		12.80		13.60		11.20	8.0		5.10		6.50		6.40
8.5		11.40		12.50		11.20	8.5		4.40		5.80		5.90
9.0		10.30		11.60		10.80	9.0		3.80		5.20		5.40
10.0				9.80		9.40	10.0				4.20		4.50
11.0				8.30		8.20	11.0				3.40		3.80
12.0				7.10		7.20	12.0				2.70		3.20
14.0				5.30		5.70	14.0				1.70		2.10
16.0				4.00		4.40	16.0				0.90		1.40
18.0				3.00		3.40	18.0						
20.0						2.60	20.0						
22.0						2.00	22.0						
24.0						1.50	24.0						
26.0						1.10	26.0						
D			0°			11°	D		0°	32°			50°
Telescoping mode	1, 2		2			2	Telescoping mode	1, 2	2	2			2
2nd Boom	0		0			0	2nd Boom	0	0	0			0
3rd Boom	0		33			67	3rd Boom	0	33	33			67
4th Boom	0		33			67	4th Boom	0	33	33			67
Top Boom	0		33			67	Top Boom	0	33	33			67

ON RUBBER STATIONARY					(Unit: × 1,000 kg)									
Over front					360° Rotation									
C \ A	12.0		20.8		C \ A	12.0		20.8		C \ A	12.0		20.8	
	B	A	B	A		B	A	B	A		B	A	B	A
0°	9.9	7.1	18.5	2.8	0°	9.9	2.8			0°	9.9	2.8		

ON RUBBER CREEP					(Unit: × 1,000 kg)								
Over front					360° Rotation								
B \ A	12.0		20.8		29.5		B \ A	12.0		20.8		29.5	
	B	A	B	A	B	A		B	A	B	A	B	A
4.0		21.10					4.0		12.10				
4.5		19.00					4.5		11.60				
5.0		17.10					5.0		10.20				
5.5		15.50					5.5		8.90				
6.0		14.10		14.60			6.0		7.80		8.10		
6.5		12.90		14.00			6.5		6.70		8.00		
7.0		11.80		13.00		11.20	7.0		5.80		7.10		
7.5		10.80		12.00		11.20	7.5		5.00		6.30		6.20
8.0		9.90		11.10		11.20	8.0		4.30		5.60		5.80
8.5		9.10		10.40		10.80	8.5		3.70		5.00		5.30
9.0		8.40		9.60		10.00	9.0		3.20		4.40		4.80
10.0				8.40		8.80	10.0				3.50		4.00
11.0				7.20		7.60	11.0				2.80		3.20
12.0				6.10		6.50	12.0				2.30		2.70
14.0				4.50		4.90	14.0				1.40		1.80
16.0				3.40		3.80	16.0						1.10
18.0				2.60		2.90	18.0						
20.0						2.30	20.0						
22.0						1.70	22.0						
24.0						1.30	24.0						
D			0°			19°	D		0°	35°			53°
Telescoping mode	1, 2		2			2	Telescoping mode	1, 2	2	2			2
2nd Boom	0		0			0	2nd Boom	0	0	0			0
3rd Boom	0		33			67	3rd Boom	0	33	33			67
4th Boom	0		33			67	4th Boom	0	33	33			67
Top Boom	0		33			67	Top Boom	0	33	33			67

ON RUBBER CREEP					(Unit: × 1,000 kg)									
Over front					360° Rotation									
C \ A	12.0		20.8		C \ A	12.0		20.8		C \ A	12.0		20.8	
	B	A	B	A		B	A	B	A		B	A	B	A
0°	9.9	6.3	18.5	2.0	0°	9.9	2.2			0°	9.9	2.2		

A: Boom length (m)
 B: Load radius (m)
 C: Loaded boom angle (°)
 D: Minimum boom angle (°) for indicated length (no load)

WARNING AND OPERATING INSTRUCTIONS FOR ON RUBBER LIFTING CAPACITIES

NOTES FOR ON-RUBBER LIFTING CAPACITIES

1. Rated lifting capacities on rubber based on crane stability are according to ISO 4305.
2. Rated lifting capacities shown in the chart are based on condition that crane is set on firm level surfaces with suspension-lock applied. They are based on actual load radius increased by tire deformation and boom deflection.
3. If the suspension-lock cylinders contain air, the axle will not be locked completely and rated lifting capacities may not be obtainable. Bleed the cylinders according to the operation safety and maintenance manual.
4. Rated lifting capacities are based on proper tire inflation, capacity and condition. Damaged tires are hazardous to safe operation of crane.
5. Tires shall be inflated to correct air pressure.

Tires	Air Pressure
29.5-25 36PR	470 kPa
29.5-25 40PR	465 kPa

6. Over front operation shall be performed within 2 degrees in front of chassis. When boom is out of 2 degrees in front of chassis, 360° capacities are effective.
7. On-rubber lifting with "jib" is not permitted. Maximum permissible boom length is 29.5 m.
8. When making lift on-rubber stationary, set parking brake.
9. For creep operation, travel slowly and keep the lifted load as close to the ground as possible, and especially avoid any abrupt steering, accelerating or braking.
10. Do not operate the crane while carrying the load.
11. Creep is motion for crane not to travel more than 60 m in any 30 minute period and to travel at the speed of less than 1.6 km/h.
12. For creep operation, choose the drive mode and proper gear according to the road or working condition.
13. The lifting capacity data stored in the AUTOMATIC MOMENT LIMITER (AML-E2) is based on the standard number of parts of line listed in the chart.
Standard number of parts of line for on-rubber operation should be according to the following table.

Boom length	12.0 m	12.0 m to 29.5 m	Single top jib
Number of parts of line	6	4	1

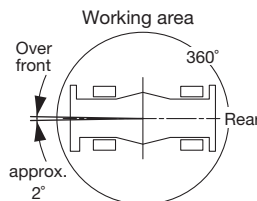

WARNING AND OPERATING INSTRUCTIONS

NOTES FOR LIFTING CAPACITIES

GENERAL

1. RATED LIFTING CAPACITIES apply only to the machine as originally manufactured and normally equipped by TADANO LTD. Modifications to the machine or use of optional equipment other than that specified can result in a reduction of capacity.
2. Hydraulic cranes can be hazardous if improperly operated or maintained. Operation and maintenance of this machine must be in compliance with information, in the Operation Manual supplied with the crane. If this manual is missing, order a replacement through the distributor.

SET UP

1. Rated lifting capacities on the chart are the maximum allowable crane capacities and are based on the machine standing level on firm supporting surface under ideal job conditions. Depending on the nature of the supporting surface, it may be necessary to have structural supports under the outrigger floats or tires to spread the loads to a larger bearing surface.
2. For outrigger operation, outriggers shall be properly extended with tires free of supporting surface before operating crane.

OPERATION

1. Rated lifting capacities based on crane stability are according to ISO 4305.
2. Rated lifting capacities are based on actual load radius increased by boom deflection.
3. The weight of handling device such as hook blocks, slings, etc., must be considered as part of the load and must be deducted from the lifting capacities.
4. Rated lifting capacities are based on freely suspended loads and make no allowance for such factors as the effect of wind, sudden stopping of loads, supporting surface conditions, inflation of tires, operating speeds, side loads, etc. Side pull on boom or jib is extremely dangerous. Such action can damage the boom, jib or slewing mechanism, and lead to overturning of the crane.
5. Rated lifting capacities do not account for wind on lifted load or boom. We recommend against working under the condition that the load is out of control due to a strong wind. During boom lift, consider that the rated lifting capacity is reduced by 50% when the wind speed is 9m/s to 12m/s; reduced by 70% when the wind speed is 12 m/s to 14 m/s. If the wind speed is 14 m/s or over, stop operation. During jib lift, stop operation if the wind speed is 9 m/s or over.
6. Rated lifting capacities at load radius shall not be exceeded. Do not tip the crane to determine allowable loads.
7. Do not operate at boom lengths, radii, or boom angle, where no capacities are shown. Crane may overturn without any load on the hook.
8. When boom length is between values listed, refer to the rated lifting capacities of the next longer and next shorter booms for the same radius. The lesser of the two rated lifting capacities shall be used.
9. When making lifts at a load radius not shown, use the next longer radius to determine allowable capacity.
10. Load per line should not exceed 6,600 kg for main winch and auxiliary winch.
11. Check the actual number of parts of line with AUTOMATIC MOMENT LIMITER (AML-E2) before operation. Maximum lifting capacity is restricted by the number of parts of line of AUTOMATIC MOMENT LIMITER (AML-E2). Limited capacity is as determined from the formula, Single line pull for main winch 6,600 kg × number of parts of line.
12. The boom angle before loading should be greater to account for deflection. For rated lifting capacities, the loaded boom angle and the load radius is for reference only.
13. The 12.0 m boom length capacities are based on boom fully retracted. If not fully retracted [less than 16.4 m boom length], use the rated lifting capacities for the 16.4 m boom length.
14. Extension or retraction of the boom with loads may be attempted within the limits of the RATED LIFTING CAPACITIES. The ability to telescope loads is limited by hydraulic pressure, boom angle, boom length, crane maintenance, etc.
15. For lifting capacity of single top, deduct the weight of the load handling equipment from the rated lifting capacity of the boom. For the lifting capacity of single top, the net capacity shall not exceed 6,600 kg including the main boom hook mass attached to the boom.
16. When the base jib or top jib or both jibs are dismantled, set the jib state switch to the DISMOUNTED position.
17. When erecting and stowing jib, be sure to retain it by hand or by other means to prevent its free movement.
18. Use "ANTI-TWOBLOCK" disable switch when erecting and stowing jib and when stowing hook block. While the switch is pushed, the hoist does not stop, even when overwind condition occurs.
19. When lifting a load by using jib (aux. winch) and boom (main winch) simultaneously, do the following:
 - Enter the operation status as jib operation, not as boom operation.
 - Before starting operation, make sure that mass of load is within rated lifting capacity for jib.
20. Before telescoping the boom, set the telescoping mode selector switch to mode 1 or mode 2 with the boom fully retracted. A change of the telescoping mode is not permissible when the boom has been partially or fully extended.
21. Traveling on road in a special steering mode (four-wheel steering, four-wheel sideways steering, etc.) is very dangerous, and must be strictly avoided. Drive the machine in two-wheel steering mode only. Special steering modes should only be used for low speed travel within work sites.
22. The lifting capacity data stored in the AUTOMATIC MOMENT LIMITER (AML-E2) is based on the standard number of parts of line listed in the chart. Standard number of parts of line for each boom length should be according to the following table.

Boom length	12.0 m	12.0 m to 20.8 m	20.8 m to 47.0 m	Single top jib
Telescoping mode	1, 2	1	2	1, 2
Number of parts of line	16	8	4	4

DEFINITIONS

1. Load Radius: Horizontal distance from a projection of the axis of rotation to supporting surface before loading to the center of the vertical hoist line or tackle with load applied.
2. Loaded Boom Angle: The angle between the boom base section and the horizontal, after lifting the rated lifting capacity at the load radius.
3. Working Area: Area measured in a circular arc about the centerline of rotation.
4. Freely Suspended Load: Load hanging free with no direct external force applied except by the hoist line.
5. Side Load: Horizontal side force applied to the lifted load either on the ground or in the air.

NOTES FOR AUTOMATIC MOMENT LIMITER (AML-E2)

- Set AML select keys in accordance with the actually operating crane conditions and don't fail to make sure, before crane operation, that the displays on front panel are correct.
- When operating crane on outriggers:
 - Set "P.T.O." switch to "ON".
 - Press the outrigger state select key to register for the outrigger operation. If the display agrees with the actual state, press the set key to register. After the completion of the registration, the display returns to the crane operation status.
 - Press the lift state select key to register the lift state to be used (single top/jib/boom).
 - Each time the lift state select key is pressed, the display changes. If the display agrees with the actual state, press the set key to register. After the completion of the registration, the display returns to the crane operation status.
 - When erecting and stowing jib, select the status of jib set (Jib state indicative symbol lights up).
- When operating crane on-rubber:
 - Set "P.T.O." switch to "ON".
 - Press the outrigger state select key to register for the on-rubber operation. Each time the outrigger state select key is pressed, the display changes. Select the creep operation, the on-rubber state indicator symbol lights up.
 - Press the lift state select key to register the lift state. However, pay attention to the following. For stationary operation.
 - The front capacities are attainable only when the over front position symbol comes on. When the boom is more than 2 degrees from centered over front of chassis, 360° capacities are in effect.
 - When a load is lifted in the front position and then slewed to the side area, make sure the value of the AUTOMATIC MOMENT LIMITER (AML-E2) is below the 360° lifting capacity.
- This machine is equipped with an automatic slewing stopping device. (For the details, see Operation and Maintenance Manual.) But, operate very carefully because the automatic slewing stop does not work in the following cases.
 - During on-rubber operation.
 - When the AML emergency operation switch is set to "ON".
- During crane operation, make sure that the displays on front panel are in accordance with actual operating conditions.
- The displayed values of AUTOMATIC MOMENT LIMITER (AML-E2) are based on freely suspended loads and make no allowance for such factors as the effect of wind, sudden stopping of loads, supporting surface conditions, inflation of tire, operating speed, side loads, etc. For safe operation, it is recommended when extending and lowering boom or slewing, lifting loads shall be appropriately reduced.
- AUTOMATIC MOMENT LIMITER (AML-E2) is intended as an aid to the operator. Under no condition should it be relied upon to replace use of capacity charts and operating instruction. Sole reliance upon AUTOMATIC MOMENT LIMITER (AML-E2) aids in place of good operating practice can cause an accident. The operator must exercise caution to assure safety.
- The lifting capacity differs depending on the outrigger extension width and slewing position. Work with the capacity corresponding to the outrigger extension width and slewing position. For the relationship among the outrigger extension width, slewing position and lifting capacities, refer to the working area charts.

GR-900EX-4 AXLE WEIGHT DISTRIBUTION CHART

		Kilograms		
		GVW	Front	Rear
Base machine incl. Jib storage, Top Jib and Base Jib		52,710	24,390	28,320
Add:	1. 90 ton 8 sheaves hook block (option)	850	1,571	-721
	2. 50 ton 5 sheaves hook block (option)	500	924	-424
	3. 35 ton 3 sheaves hook block (option)	450	832	-382
Remove:	1. 6.6 ton hook block	-165	-251	86
	2. Top jib (option)	-336	-450	114
	3. Base jib (option)	-867	-1,704	837
	4. Counterweight	-9,800	3,825	-13,625



TADANO

TADANO LTD. (International Sales Division)

KANDA SQUARE 18th Floor,
2-2-1 Kanda-Nishikicho,
Chiyoda-ku, Tokyo 101-0054, Japan

Phone : +81-3-6811-7309

[URL](http://www.tadano.com) www.tadano.com

[E-mail](mailto:info@tadano.com) info@tadano.com

Printed in Japan
2022-10-1