



Lifting your dreams

TRUCK LOADER CRANE

TM-ZX1000HRS/HS

For Large Size Vehicles

CARGO CRANE



Note: Some specifications are subject to change.



Tadano Ltd.
KANDA SQUARE 18th Floor,
2-2-1 Kanda-Nishikicho, Chiyoda-ku, Tokyo 101-0054, Japan
Phone: +81-3-6811-7309
www.tadano.com E-mail: info@tadano.com



©Tadano Ltd. 2023
TM-ZX1000HRS/HS-E-23-8-000-70-631-B1
Printed in Japan

Safe and Comfortable Operations through Sensor Monitoring.

TM-ZX1000 monitors the crane with the "Safety Eyes" system, and is equipped with various "safety devices" made by mobilizing the best technologies as standard, and provides further security and safety for you.



Safety Eyes

See p. 3-4 →

TM-ZX1000HRS/HS

Radio Controller with Color LCD* Display *Liquid-crystal Display

A radio controller for remotely operating the crane is optionally provided, and it employs a large-screen and power-saving color LCD display, has a feature that can customize speed adjustment for various operations, and has an emergency stop switch in addition to displaying the actual load, rated load, and moment load ratio. The "load weight" function enables to check the work progress and the load weight on the vehicle, which also prevents overloading.

Note: TM-ZX1005HS model does not include radio controller.



WATER-RESISTANCE [IPX6K]

Emergency stop



AML (Automatic Moment Limiter)

The AML that monitors crane work safety is equipped as standard and it provides a "strength monitoring" function, which prevents crane overloading, and a "stability monitoring" function, which prevents the crane from falling over.



Manually entering the number of parts of line in use allows for fine-tuned controls. As the crane approaches rated performance, warning alarms and lamps are triggered. As an extra level of safety, operation is automatically stopped once critical parameters are reached.



Safety Eyes



"Safety Eyes" system consists of an "Automatic Moment Limiter", "Boom jack interlock system", and a "Working height limiter", etc., to monitors work safety. This system enables work to be performed safely.

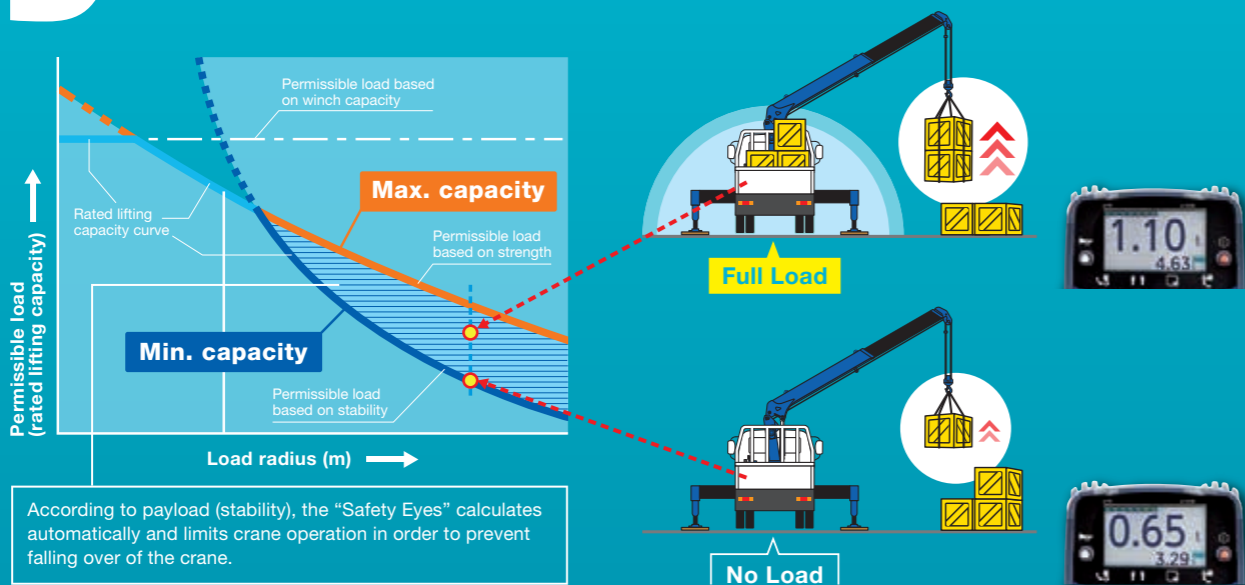

Carry Heavier Loads When Close

Carry Loads Farther When Light

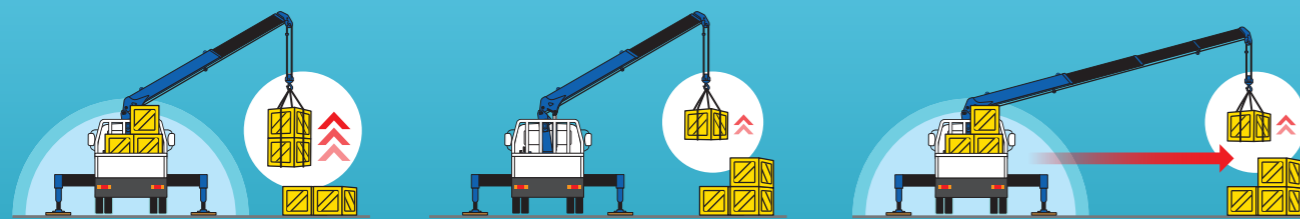

Calculations are automatic based on loaded cargo (stability), allowing you to carry heavier loads farther when fully loaded.

Feeling Operation

The operation speed of the machine when the trigger is pulled can be increased or decreased from the standard speed.



Registering Hook Block and Number of Parts of Line

Every time the hook block/part line select switch on the conroll panel is pressed, the indications of the hook block and the number of parts of line change.

Outriggers Asymmetric Extension Width Control

Optimum Lifting Performance at Any Outrigger Width!

Constantly monitors slewing angle and difference in outrigger extension widths. Operation automatically slows and stops as critical parameters are approached.

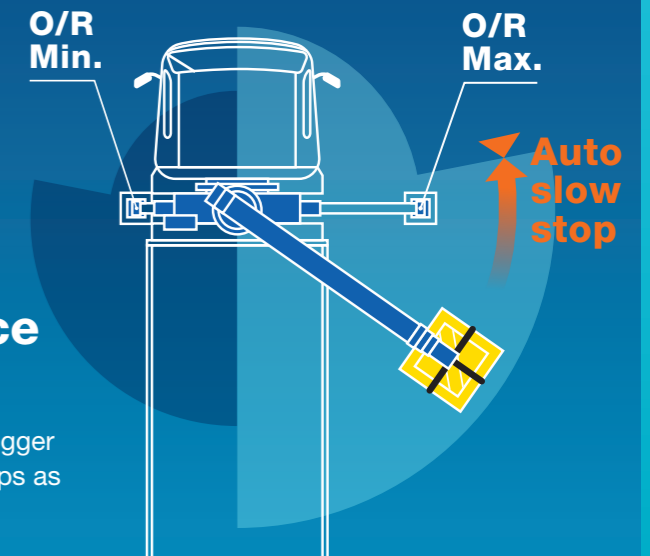

Working Height Limiter

A function to preset the upper limit of the boom height (stop position). This is quite effective in work sites where attention is required to the boom height, such as under power lines and indoors.

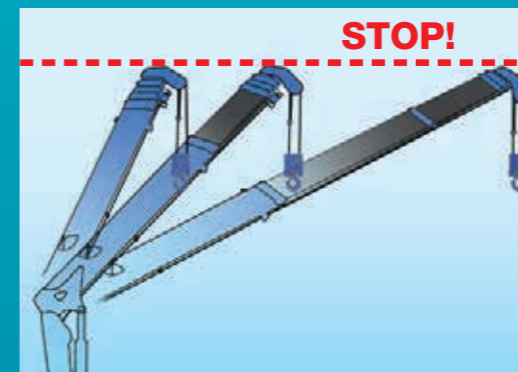

Jack Interlock

Disables crane operation when the left or right jack is not in contact with the ground.



Safety Lamp Equipped Centralized Control Panel

See p. 7 →

As operation begins to approach critical levels, safety lamps begin to flash (preliminary warning). If operation continues past this point, warning lights grow more intense once the danger level reaches 100% (limit warning).

Limit Warning Lamp

Warning lights on the control panel, remote control and vehicle (tricolor vehicle light) work in tandem, making it easy to see even at a distance from the crane.

Limit warning lamps (three-color)



Radio controller



Centralized control panel



**Optional for TM-ZT1005HS/HS

TM-ZX1000HRS

Loader Crane for Large Size Vehicles

Hook-in / out System

Tadano original hook-in system is equipped as standard and enhances work efficiency. During hook-out, the boom hoists automatically to avoid hitting cargo.



Anti-two-block Function

This function stops crane operation (hoisting up, boom elevation, and boom extension) when the hook block touches the weight, and warns the operator with an alarm, to prevent the hook block from hitting the boom head.

High-powered Radio Controller

Radio Controller with powerful transmitting output automatically selects a frequency free of jamming, out of as many frequencies as 40 channels, to avoid interference troubles.

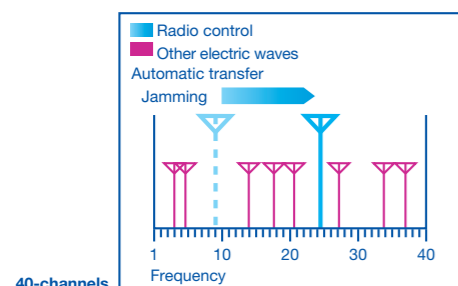

Strong Pentagonal Boom

Tadano's strong and light Pentagonal boom made of high tensile steel thoroughly designed and well proven for its quality, strength and smoothness, with a rigid and fine-tuned telescoping boom providing comfortable crane operation.

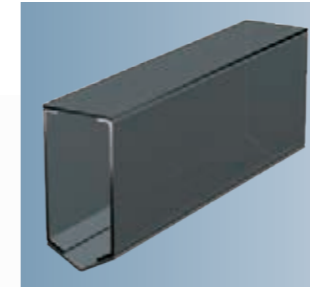

Automatic Slewing Lock System

The boom is mechanically locked securely at the boom post base to prevent the boom from accidentally slewing out during travel.

Powerful Elevating Cylinder

The cylinder uses hydraulic, control, and processing technologies cultivated from more than 50 years of manufacturing experience, supporting greater work capacity.

Cable Follower

The cable follower prevents disorderly cable (wire rope) winding by always pressing the cable onto the winch drum and puts the wire rope at a right position.

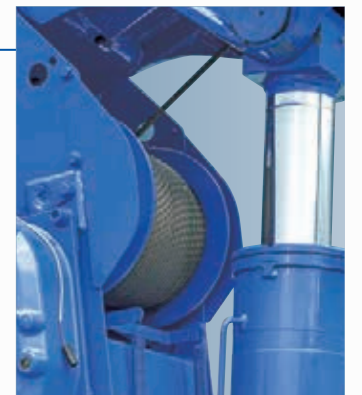

Strong Outrigger with Safety Lock

Strong 5.2 m width and powerful outriggers with box structure jacks, an easy and safe lock system together with new universal floats. The lock system is one of the advanced reliable Tadano standard safety systems. Left and right outriggers can also be exchanged with no change in functionality.

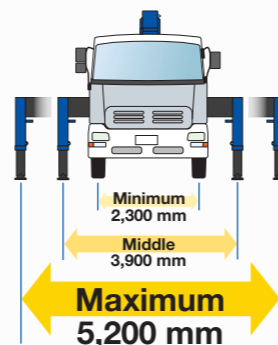

Big Hydraulic Tank

Big hydraulic tank with approximately 90 liter capacity.

Tiltable Front Outrigger Jack Float

The universal float rotates 360 degrees to fit any ground, for better stability. Large floats reduce ground pressure.

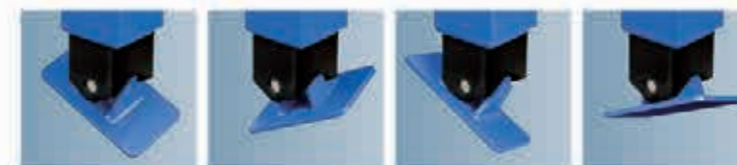
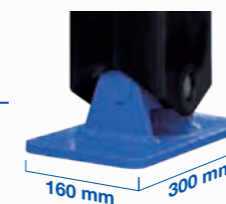

Centralized Control Panel

On the upper section, the digital displays for the actual load and empty chassis rated lifting capacity are built in. In addition, the limit warning lamp and outrigger extension status indicator lamp are provided. The control panel also indicates the empty chassis rated lifting capacity table and working range chart. Various functional switches are compactly gathered on the lower section.

Over-front area
Limit warning lamp

Outrigger extension status
Actual load
Empty chassis rated lifting capacity
Moment load ratio

Rated lifting capacities display
Crane strength rated lifting capacities (t) and load ratio (%) can be displayed with display switching function.

Mode display
Actual load (t) and total PTO ON time (hrs) can be displayed with display switching function.

Hour meter
Displays the crane operating hours as a guide for the maintenance timing.

Numeric keypad display

Photo: Control levers and new centralized control panel (on the right side of the main body)

Emergency Stop

Use this switch to halt the machine movement if the machine cannot be controlled during crane operation, and in an emergency. (Outrigger operation does not stop.)

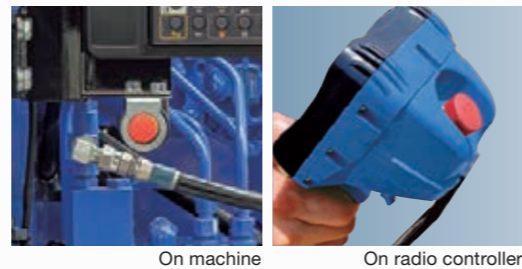

Spirit Level

Used to check that the machine is set horizontally in left and right directions when the outriggers are set up.



OPTIONAL EQUIPMENT for TM-ZX1000HRS/HS

Limit Warning Lamps (Three-color)*

The external AML warning lamp uses LEDs to show the moment load ratio in three colors, helping to prevent the crane from falling over and damage due to overloading, and other accidents.



Oil Cooler

The oil cooler maintains the temperature of the hydraulic oil low, keeping it safe and improving the operating efficiency of the crane. Use the oil cooler to cool the hydraulic oil when the oil temperature rises significantly, such as when the machine is used continuously at high load.



Rear Outriggers

(outrigger beam extension type)
(outrigger beam non-extension type)

The photo shows outrigger beam non-extension type.



Basket Mounting Support

*Optional for TM-ZX1000HRS only



Basket Mode Working Range

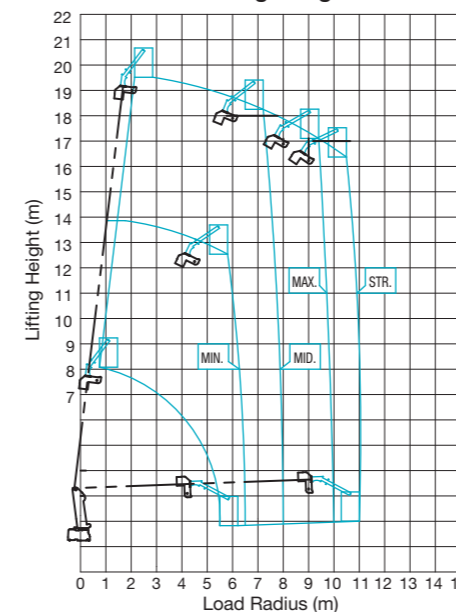

Mountable basket specifications (When using optional basket mounting support)

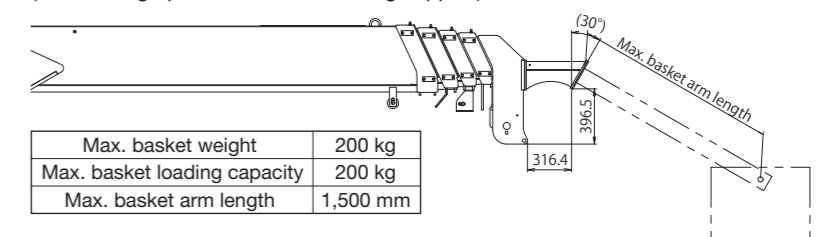

Basket Mode Working Range Notes:

- The indicated working range assumes that the machine is set up on a firm and level ground, and does not include boom deflection.
- This working range chart shows the over-side and over-rear areas. (The working range is up to "STR." when the stability is maximum. When the stability is minimum, the working range is in accordance with the outrigger extension width during work.)
- The working range in the over-front area is smaller than the indication in the working range chart.
- "MAX.", "MID.", and "MIN." indicates the outrigger extension widths.
- This working range chart is an example, and the actual work range varies depending on the shape of the basket.

TM-ZX1000HRS/HS

Technical Specifications

Model	TM-ZX1005HRS/HS
MAXIMUM LIFTING CAPACITY	10,000 kg at 1.4 m (8 parts of line)
CRANE CAPACITY	4,900 kg at 3.1 m (4 parts of line)
BOOM	Five-sectioned, fully powered partly synchronized telescoping boom of pentagonal box construction with 4 sheaves at boom head
Sections	5
Length	4.40 m-15.92 m
Extending speed	11.5 m in 38 s
Elevation	Elevated by a double-acting, Hydraulic cylinder
Raising speed	1° to 82° in 17 s
Boom point	4 sheaves
WINCH	Hydraulic motor driven spur gear speed reduction, provided with mechanical brake and cable follower
Single line pull	14.72 kN {1,500 kgf}
Single line speed	44 m/min. (at 4th layer)
Wire rope (Diameter x length)	10 mm x 95 m
Wire rope (Breaking strength)	73.5 kN (7,500 kgf)
Wire rope (Construction)	7 x 7 + 6 x Fi (29)
Hook block	4 sheaves
HOOK BLOCK STOWING DEVICE	Mechanically stowed beneath boom top portion
SLEWING	•Hydraulic motor driven worm gear speed reduction •Continuous 360°full circle slewing on ball bearing slew ring •Automatic slewing lock
Slewing speed	2.2 min ⁻¹ (rpm)
OUTRIGGERS	Hydraulically operated beams and jacks integral with crane frame
Extended width	Max. 5.2 m, Mid. 3.9 m, Min. 2.3 m
HYDRAULIC SYSTEM	
Hydraulic pump	Single gear pump
Hydraulic motors	Axial piston type for winch and slewing
Control valves	Multiple control valves with integral safety valves
Oil tank capacity	Approx. 102 liters
RADIO CONTROLLER (TM-ZX1000HRS only)	Model : RCS-F (with colored display) Control functions of telescoping, hoisting up and down, elevating, slewing, acceleration, Hook-in, Hook-out, horn, stop operation and working height limit.
Frequency	40 frequencies in 433 MHz band
Operating power supply	
Transmitter	6 V DC, Dry battery R6 P (SUM-3) x 4
Control unit	24 V DC, Vehicle battery
Transmitter mass	Approx. 670 g (includes batteries)
SAFETY DEVICES	•Anti-two-block device •AML (Automatic Moment Limiter) <Load indication, Load moment ratio indication, Warning alarm, Rated capacity, indicator/limiter or Rated capacity indicator, Limit warning lamp, Outrigger length detector, Outrigger asymmetric extension width control> •Limit warning lamp (three-color), •WHL (Working Height Limiter) •Boom angle indicator •Over unwinding prevention •Hook safety latch •Spirit level •Jack interlock •Boom/outrigger stowing reminder alarm •Emergency stop switch •(*1) Stop switch on radio controller •Hydraulic safety valves, check valves and holding valves
OPTIONAL EQUIPMENT	•Outrigger pads •Oil cooler •Rear outriggers (outrigger beam extension type) •Rear outriggers (outrigger beam non-extension type) •(*1) Basket mounting support •Maintenance valve
CRANE MASS	Approx. 3,140 kg (Except crane option and mounting parts)

Note: Each operating speeds show the value when there is no load conditions and the pump delivery is the following conditions.

- 36 L/min (Slewing speed)
- 60 L/min (BOOM: Extending speed, Raising speed WINCH: Single line speed)
- *1 : TM-ZX1000HRS only.

Working Range (4 parts of line)

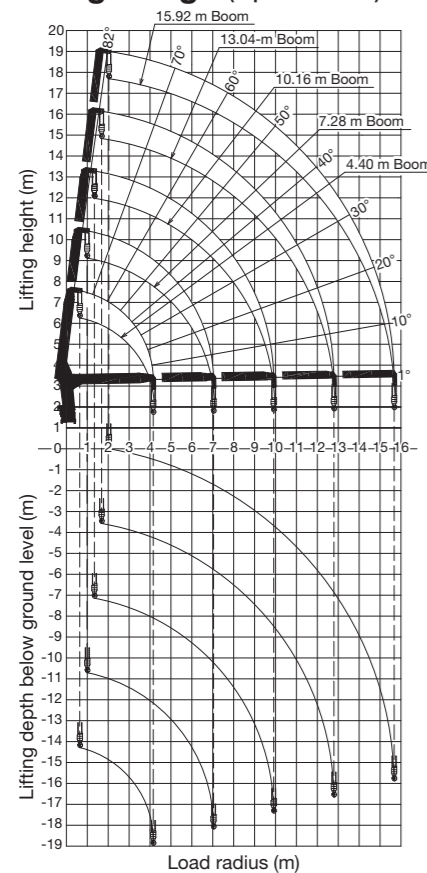

Note: Boom deflection, subsequent radius and boom angle change must be accounted for when applying load to hook block.

Dimensions

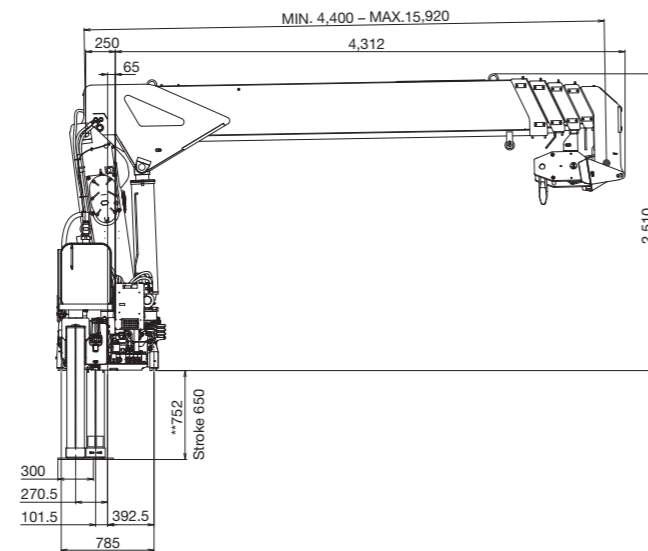

Rated Lifting Capacities (x 1,000 kg)

Crane strength rated capacities

<Over-side, over-rear area> (Over-front area: 25% of empty chassis rated lifting capacity.)

Table A

● 4.40 m boom		1.4 and below	1.85	2.25	3.1	3.5	4.15					
Load radius (m)		1.4 and below	1.85	2.25	3.1	3.5	4.15					
Crane Strength		10.00	8.00	6.00	4.90	4.20	3.55					
Empty Chassis	Extension width of outriggers	Max.	10.00	8.00	6.00	4.90	4.20	3.55				
		Mid.	10.00	8.00	6.00	4.90	4.20	3.15				
		Min.	10.00	7.15	4.55	2.40	1.90	1.30				
● 7.28 m boom		2.25 and below	3.1	3.5	4.0	4.5	5.0	6.0	7.03			
Load radius (m)		2.25 and below	3.1	3.5	4.0	4.5	5.0	6.0	7.03			
Crane Strength		6.00	4.90	4.20	3.70	3.30	2.90	2.20	1.75			
Empty Chassis	Extension width of outriggers	Max.	6.00	4.90	4.20	3.70	3.30	2.90	2.20	1.60		
		Mid.	6.00	4.90	4.20	3.35	2.60	2.10	1.45	1.00		
		Min.	4.40	2.30	1.80	1.35	1.05	0.80	0.50	0.25		
● 10.16 m boom		4.5 and below	5.0	6.0	7.0	8.0	9.0	9.91				
Load radius (m)		4.5 and below	5.0	6.0	7.0	8.0	9.0	9.91				
Crane Strength		3.00	2.70	2.20	1.80	1.40	1.15	1.00				
Empty Chassis	Extension width of outriggers	Max.	3.00	2.70	2.20	1.60	1.25	1.00	0.75			
		Mid.	2.60	2.10	1.45	1.00	0.80	0.60	0.45			
		Min.	1.05	0.80	0.50	0.25	0.20	-	-			
● 13.04 m boom		4.5 and below	5.0	6.0	7.0	8.0	9.0	10.0	11.0	12.0	12.7	
Load radius (m)		4.5 and below	5.0	6.0	7.0	8.0	9.0	10.0	11.0	12.0	12.7	
Crane Strength		3.00	2.60	2.00	1.70	1.40	1.15	1.00	0.90	0.75	0.65	
Empty Chassis	Extension width of outriggers	Max.	3.00	2.60	2.00	1.60	1.25	1.00	0.75	0.65	0.50	
		Mid.	2.60	2.10	1.45	1.00	0.80	0.60	0.45	0.35	0.30	0.25
		Min.	2.60	2.10	1.45	1.00	0.80	0.60	0.45	0.35	0.30	0.25
● 15.92 m boom		5.0 and below	6.0	7.0	8.0	9.0	10.0	11.0	12.0	13.0	14.0	15.67
Load radius (m)		5.0 and below	6.0	7.0	8.0	9.0	10.0	11.0	12.0	13.0	14.0	15.67
Crane Strength		2.60	2.00	1.65	1.40	1.15	1.00	0.90	0.75	0.65	0.55	0.45
Empty Chassis	Extension width of outriggers	Max.	2.60	2.00	1.60	1.25	1.00	0.75	0.65	0.55	0.50	0.45
		Mid.	2.10	1.45	1.00	0.80	0.60	0.45	0.35	0.30	0.25	0.20
		Min.	2.10	1.45	1.00	0.80	0.60	0.45	0.35	0.30	0.25	0.20

Table D

● 4.40 m boom		1.4 and below	1.85	2.25	3.1	3.5	4.15					
Load radius (m)		1.4 and below	1.85	2.25	3.1	3.5	4.15					
Crane Strength		10.00	8.00	6.00	4.90	4.20	3.55					
Empty Chassis	Extension width of outriggers	Max.	10.00	8.00	6.00	4.90	4.20	3.55				
		Mid.	10.00	8.00	6.00	4.90	4.20	3.55				
		Min.	10.00	8.00	5.65	3.00	2.40	1.70				
● 7.28 m boom		2.25 and below	3.1	3.5	4.0	4.5	5.0	6.0	7.03			
Load radius (m)		2.25 and below	3.1	3.5	4.0	4.5	5.0	6.0	7.03			
Crane Strength		6.00	4.90	4.20	3.70	3.30	2.90	2.20	1.75			
Empty Chassis	Extension width of outriggers	Max.	6.00	4.90	4.20	3.70	3.30	2.90	2.20	1.75		
		Mid.	6.00	4.90	4.20	3.35	2.60	2.80	1.95	1.40		
		Min.	5.50	2.90	2.30	1.75	1.40	1.10	0.75	0.45		
● 10.16 m boom		4.5 and below	5.0	6.0	7.0	8.0	9.0	9.91				
Load radius (m)		4.5 and below	5.0	6.0	7.0	8.0	9.0	9.91				
Crane Strength		3.00	2.70	2.20	1.80	1.40	1.15	1.00				
Empty Chassis	Extension width of outriggers	Max.	3.00	2.70	2.20	1.80	1.40	1.15	1.00			
		Mid.	3.00	2.70	1.95	1.40	1.15	0.90	0.70			
		Min.	1.40	1.10	0.75	0.45	0.35	0.20	-			
● 13.04 m boom		4.5 and below	5.0	6.0	7.0	8.0	9.0	10.0	11.0	12.0	12.7	
Load radius (m)		4.5 and below	5.0	6.0	7.0	8.0	9.0	10.0	11.0	12.0	12.7	
Crane Strength		3.00	2.60	2.00	1.70	1.40	1.15	1.00	0.90	0.75	0.65	
Empty Chassis	Extension width of outriggers	Max.	3.00	2.60	2.00	1.70	1.40	1.15	1.00	0.90	0.75	
		Mid.	3.00	2.60	1.95	1.40	1.15	0.90	0.70	0.60	0.50	
		Min.	3.00	2.60	1.95	1.40	1.15	0.90	0.70	0.60	0.50	
● 15.92 m boom		5.0 and below	6.0	7.0	8.0	9.0	10.0	11.0	12.0	13.0	14.0	15.67
Load radius (m)		5.0 and below	6.0	7.0	8.0	9.0	10.0	11.0	12.0	13.0	14.0	15.67
Crane Strength		2.60	2.00	1.65	1.40	1.15	1.00	0.90	0.75	0.65	0.55	0.45
Empty Chassis	Extension width of outriggers	Max.	2.60	2.00	1.60	1.40	1.15	1.00	0.90	0.75	0.65	0.55
		Mid.	2.60	1.95	1.40	1.15	0.90	0.70	0.60	0.50	0.40	0.30
		Min.	2.60	1.95	1.40	1.15	0.90	0.70	0.60	0.50	0.40	0.30

- Notes : 1. Rated capacity indicator issues warning with the limit warning lamp and the buzzer when the working state approaches the stability limit or the strength limit.
 2. When the AML is equipped with the rated capacity limiter, an operation stops automatically if the rated lifting capacity is exceeded.
 3. When the crane is front mounted, set up the front outriggers so that the front wheels are slightly in contact with the ground. (If tire deformation is large, AML may activate earlier.)
 4. Empty Chassis Rated Capacities in these tables depend on condition that crane is set level on firm level ground.
 5. This value has been calculated on the basis of ISO 15442.
 6. This value includes the mass of lifting devices such as hook block (95 kg).
 7. This load radius shows actual load radius which includes boom deflection.
 8. Rated lifting capacity is in consideration of the loading on the truck bed, and is within the range from the empty chassis rated lifting capacity to the crane strength rated lifting capacity.
 9. If the boom length exceeds the table value even a little, the performance is limited to the performance of the next boom length.
 10. When the lifting load is heavier than 6,000 kg, number of part lines must be 8. In case of 6,000 kg or less, number of part lines must be 4. Load per line must not surpass 14.7 kN (1,500 kgf).

Number of part line	4	8
Maximum of load	6,000 kg	10,000 kg

11. Empty chassis rated lifting capacity varies according to the working area.
 • Front mounting <over-side, over-rear area> : 100%
 • <over-front area> : 25% (*2) or 60% (*2) or 100% (*2)
 *2 : Depend on the types of chassis.
 12. Empty Chassis Rated Capacities table A and D depend on the types of chassis. (The following table shows guidelines for bodywork vehicles that can achieve the rated lifting capacity tables A and D for vehicles with front 1-axis and rear 2-axis. Be sure to carry out a stability inspection to determine which performance to apply.)

A	5500 mm ≤ WB (*3), 25 t ≤ GVW, 3.0 t ≤ CAWf (*4)
D	5500 mm ≤ WB (*3), 25 t ≤ GVW, 4.0 t ≤ CAWf (*4)

- *3 : From the front axle to the farthest rear axle.
 *4 : Chassis front axle weight (excluding crane and mounting parts mass).

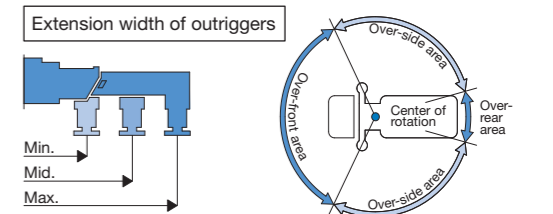

Truck mount

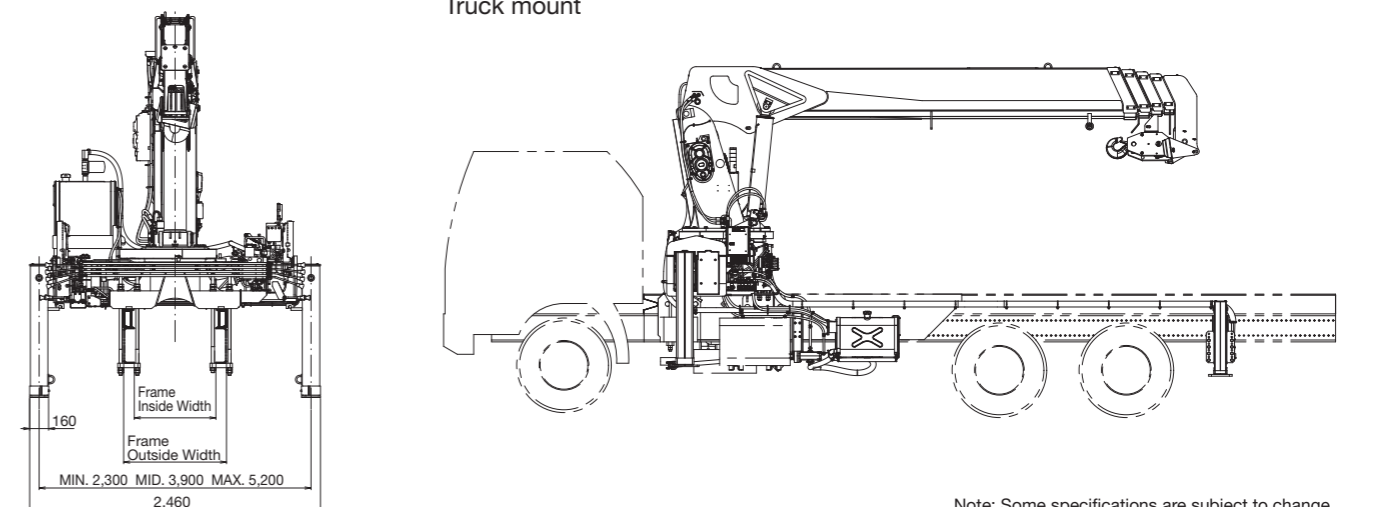

Note: Some specifications are subject to change.

(mm)