

# OPTIONAL EQUIPMENT

for TM-ZX1500HRS/HS

## Oil Cooler

The oil cooler maintains the temperature of the hydraulic oil low, keeping it safe and improving the operating efficiency of the crane.

Use the oil cooler to cool the hydraulic oil when the oil temperature rises significantly, such as when the machine is used continuously at high load.

## Basket Mounting Support

Baskets that conform to the following specs can be mounted on the crane:

- Basket weight: 200 kg or less
- Basket capacity: 200 kg or less
- Basket arm length: 1,700 mm or less

Please mount the basket according to the basket's user manual.

Optional for TM-ZX1505HRS only



## 15 ton Hook Block

5 sheaves for 10 parts of line with 1 additional sheave for the boom point  
(Hook block weight: 110 kg)

Note: The standard specification is a 9 ton hook block.



NOTE: Some specifications are subject to change.



Lifting your dreams

TRUCK LOADER CRANE

# TM-ZX1500HRS/HS

For Large Size Vehicles



# CARGO CRANE



Tadano Ltd.  
KANDA SQUARE 18th Floor,  
2-2-1 Kanda-Nishikicho, Chiyoda-ku, Tokyo 101-0054, Japan  
Phone: +81-3-6811-7309  
www.tadano.com E-mail: info@tadano.com



©Tadano Ltd. 2023  
TM-ZX1500HRS/HS-1-E-23-8-000-70-632-B4  
Printed in Japan

# Safer, stronger, farther — maximum performance through sensor monitoring.

"Crane operation is more stable with a load in the bed."

It's something we've always known, but until now could only rely

on the operator's experience and senses to know how far was too far.

The TM-ZX1500's equipped sensors, however,

measure cargo load weight and reflect that sense of stability in crane functionality.

## TM-ZX1500HRS/HS



### Safety Eyes [See p. 3-4](#)



**WATER &  
DUST-RESISTANCE**  
[IP66K\*\*]

Emergency stop

### Radio Controller with Color LCD\* Display \*Liquid-Crystal Display

The loader crane has an optional remote control, which employs a large-screen and power-saving color LCD display, has a feature that can customize speed adjustment for various operations, and has an emergency stop switch in addition to displaying actual load, rated load, and moment load ratio.

The newly developed "load weight" function calculates and displays load weight during loading and unloading, enabling work progress and the load weight on the vehicle to be checked, which also prevents overloading. These features contribute to not only the safety of crane work, but also to the safety of the vehicle when it is traveling.

Note: TM-ZX1505HS model does not include controller.

\*\*The IP rating indicates water proofness and dust proofness as defined in IEC 60529. An IP66K rating indicates an exceptional level of water and dust proofness, ensuring peace of mind.



### AML (Automatic Moment Limiter)

The AML that monitors crane work safety is equipped as standard and it provides a "strength monitoring" function, which prevents crane overloading, and a "stability monitoring" function, which prevents the crane from falling over.

Manually entering the number of parts of line in use allows for fine-tuned controls. As the crane approaches rated performance, warning alarms and lamps (on radio controller\*\*\*, three-color limit warning lamps and control panel) are triggered. In order to ensure safety, operation is automatically stopped or warning alarms are triggered once critical parameters are reached.

This system helps support both safety and ease-of-use for the operator.

\*\*\*TM-ZX1505HRS only.

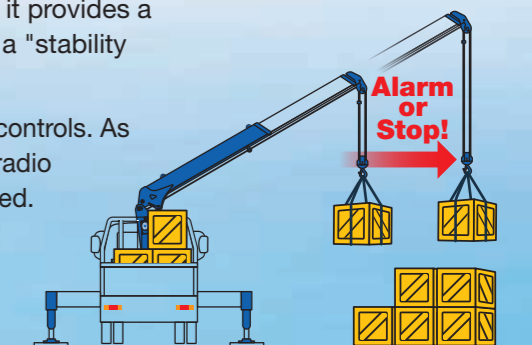

# Safety Eyes



"Safety Eyes" system consists of an "Automatic Moment Limiter", a "Boom jack interlock system", and a "Working height limiter", etc., to monitor operation. This system enables work to be performed safely.

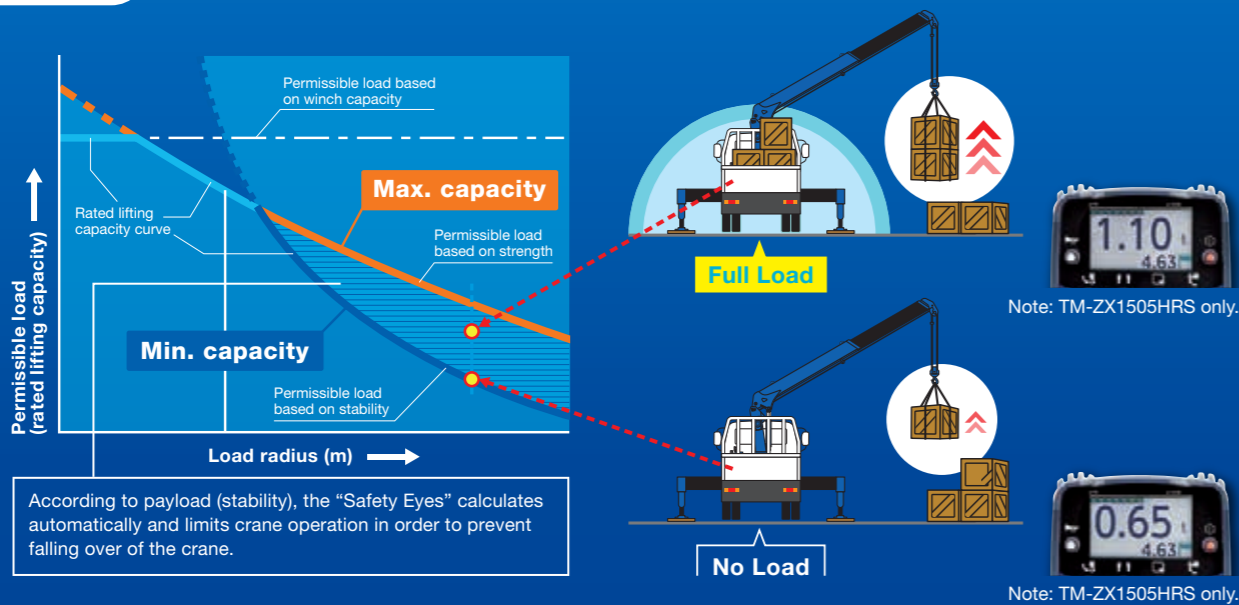

Carry Heavier Loads When Close

Carry Loads Farther When Light

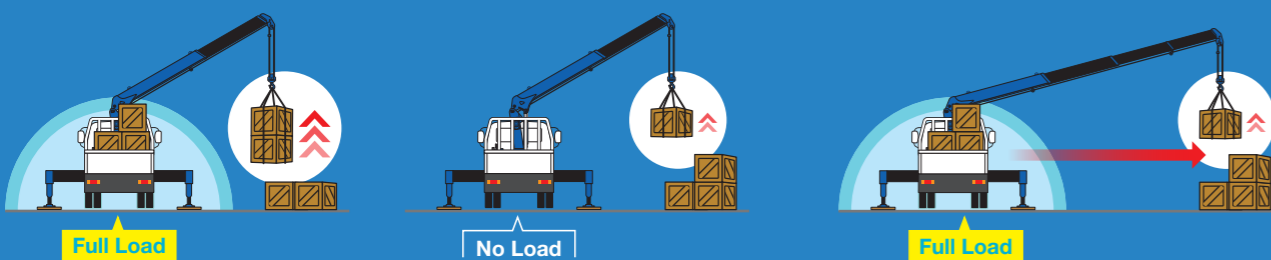

Calculations are automatic based on loaded cargo (stability), allowing you to carry heavier loads farther when fully loaded.

## Feeling Operation

The operation speed of the machine when the trigger is pulled can be increased or decreased from the standard speed.

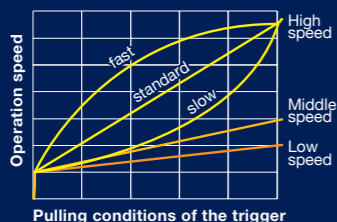

## Registering the Hook Block and Number of Parts of Line

Every time the hook block/part line select switch on the control panel is pressed, the indications of the hook block and the number of parts of line change.



## Outriggers Asymmetric Extension Width Control

### Optimum Lifting Performance at Any Outrigger Width

Constantly monitors slewing angle and difference in outrigger extension widths. Crane motion is controlled according to the extension width of each outrigger.

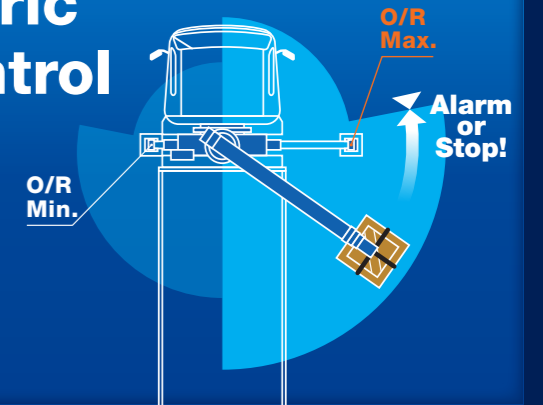

## Working Height Limit Function

A function to preset the upper limit of the boom height (stop position). This is quite effective in work sites where attention is required to the boom height, such as under power lines and indoors.

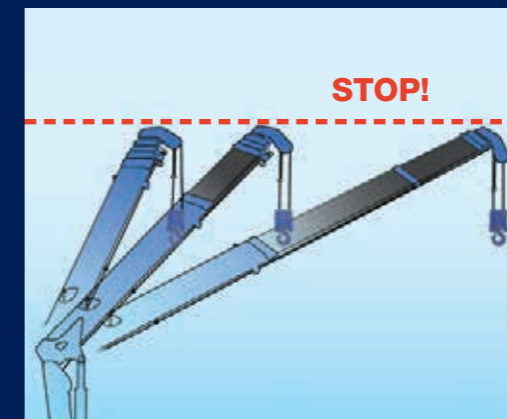

## Jack Interlock

Disables crane operation when the left or right jack is not in contact with the ground.



## Safety Lamp Equipped Centralized Control Panel

As operation begins to approach critical levels, safety lamps begin to flash (preliminary warning). If operation continues past this point, warning lights grow more intense once the danger level reaches 100% (limit warning).

See p. 7

## Limit Warning Lamp

Warning light on the control panel, moment indicator in the radio controller and three-color limit warning lamp at crane post and warning alarm respectively work in tandem.

### Limit warning lamp

#### Rated lifting capacity display

Crane strength rated lifting capacity (t) and load ratio (%) can be displayed with display switching function.

#### Mode display

Actual load (t) and total PTO ON time (hrs) can be displayed with display switching function.



\*TM-ZX1505HRS only

# TM-ZX1500

# HRS/HS

## Cargo Crane for Large Size Vehicles

### Strong Outrigger with Safety Lock

Strong 5.8 m width and powerful outriggers with box structure jacks, an easy and safe lock system together with new universal floats. The lock system is one of the advanced reliable Tadano standard safety systems.

Left and right outriggers can also be exchanged with no change in functionality.

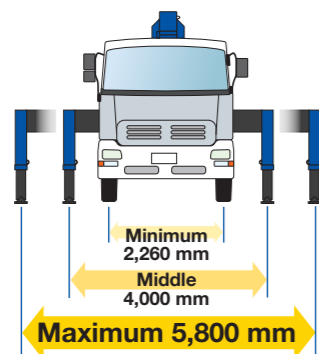

Outrigger lock pin (Both sides)

### Two Powerful Elevating Cylinders

These cylinders use hydraulic, control, and processing technologies cultivated from more than 50 years of manufacturing experience, supporting greater work capacity.

### Cable Follower

The cable follower prevents disorderly cable (wire rope) winding by always pressing the cable onto the winch drum and puts the wire rope at a right position.



### High-powered Radio Controller

Radio Controller with powerful transmitting output automatically selects a frequency free of jamming, out of as many frequencies as 40 channels, to avoid interference troubles.

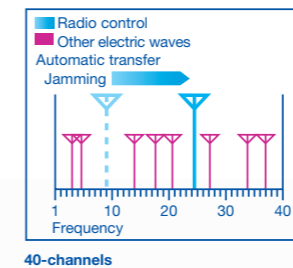

Note: TM-ZX1505HRS only.

### Automatic Slewing Lock System

The boom is mechanically locked securely at the boom post base to prevent the boom from accidentally slewing out during travel.

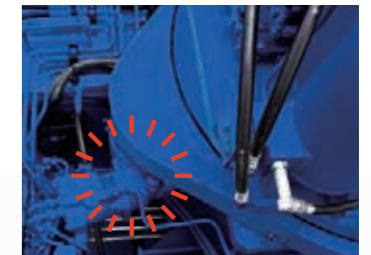

### Anti-two-block Function

This function stops crane operation (hoisting up, boom elevation, and boom extension) when the hook block touches the weight, and warns the operator with an alarm, to prevent the hook block from hitting the boom head.

### Hook-in / out System

Tadano original hook-in system is equipped as standard and enhances work efficiency. During hook-out, the boom raises automatically to avoid hitting cargo.



Note: Hook-in of 15 ton hook block is not possible.

### Strong Heptagonal Boom

Tadano's strong and light heptagonal boom made of high tensile steel thoroughly designed and well proven for its quality, strength and smoothness, with a rigid and fine-tuned telescoping boom providing comfortable crane operation.



### Tiltable Front Outrigger Jack Float

The universal float rotates 360 degrees to fit any ground, for better stability. Large floats reduce ground pressure.



### Big Hydraulic Tank

Big hydraulic tank with approximately 130 liter capacity.

## Centralized Control Panel

On the upper section, the digital displays for the actual load and crane strength rated lifting capacity are built in. In addition, the limit warning lamp and outrigger extension status indicator lamp are provided. The control panel also displays the values of the empty chassis rated lifting capacity and the crane strength rated lifting capacity, and the working range chart. Various functional switches are compactly gathered on the lower section.

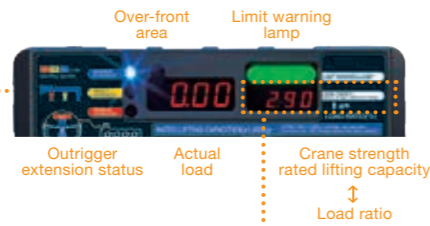

### Rated lifting capacity display

Crane strength rated lifting capacity (t) and load ratio (%) can be displayed with display switching function.



Numeric keypad display

### Mode display

Actual load (t) and total PTO ON time (hrs) can be displayed with display switching function.

### Hour meter

Displays the crane operating hours as a guide for the maintenance timing.

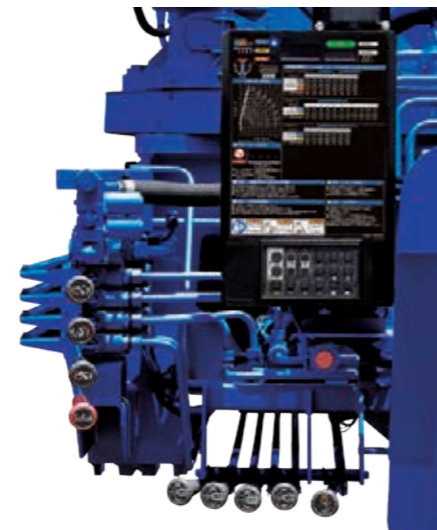

Control levers and new centralized control panel (on the right side of the main body)

## Emergency Stop

Use this switch to stop the machine movement if the machine cannot be controlled during crane operation, and in an emergency. (Outrigger operation does not stop.)



On machine



On radio controller  
Note: TM-ZX1505HRS only.

## Spirit Level

Used to check that the machine is set horizontally in left and right directions when the outriggers are set up.



## OPTIONAL EQUIPMENT Basket Mode

Optional for TM-ZX1505HRS only

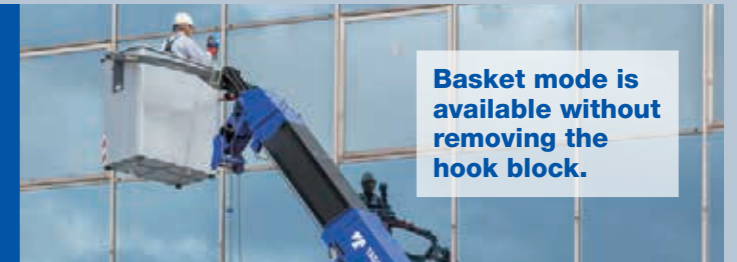

Basket mode is available without removing the hook block.

## Basket Mode Working Range

Working range is calculated by strict safety measures, it makes us work with safety.

Note: In order to ensure safety, the crane will automatically stop when in basket mode even with alarm specification.

Table A

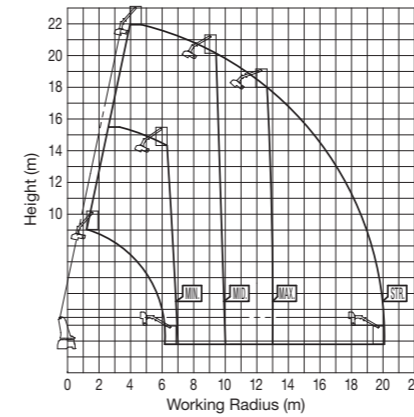

Table B

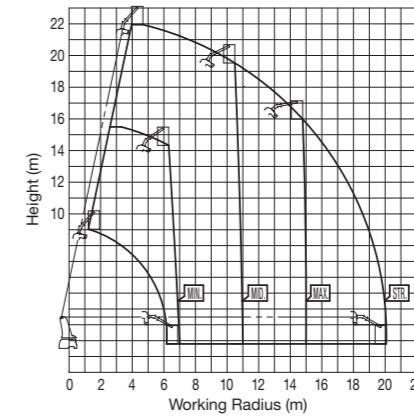
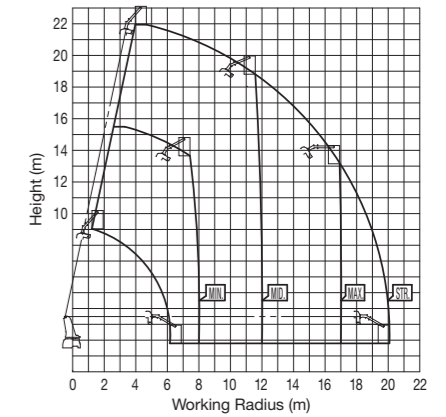

Table C



Basket Mode Working Range Notes:

- The indicated working range assumes that the machine is set up on a firm and level ground, and does not include boom deflection.
- This working range chart shows the over-side and over-rear areas. (The working range is up to "STR." when the stability is maximum. When the stability is minimum, the working range is in accordance with the outrigger extension width during work.)
- The working range in the over-front area is smaller than the indication in the working range chart.
- "MAX.", "MID.", and "MIN." indicate the outrigger extension widths.
- This working range chart is an example, and the actual work range varies depending on the shape of the basket.

## Mountable basket specifications

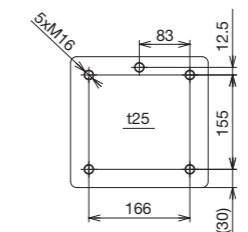
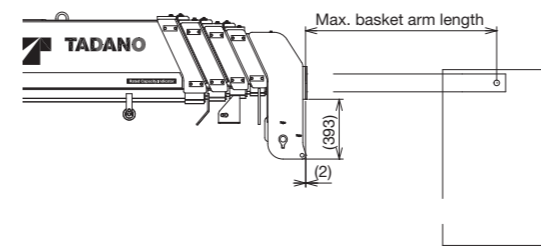

Basket mounting plate

Max. basket weight	200 kg
Max. basket loading capacity	200 kg
Max. basket arm length	1,700 mm

- The size of mounting bolt is M16x2.0, and the length should be selected so that the engagement allowance is 13 mm or more and 24 mm less.
- Use bolts with a strength classification of 10.9 or equivalent and washers suitable for the bolts.
- Tightening torque : 147±8 [N · m]

(When using optional basket mounting support)

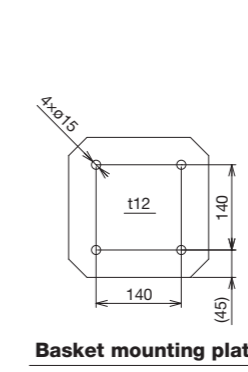
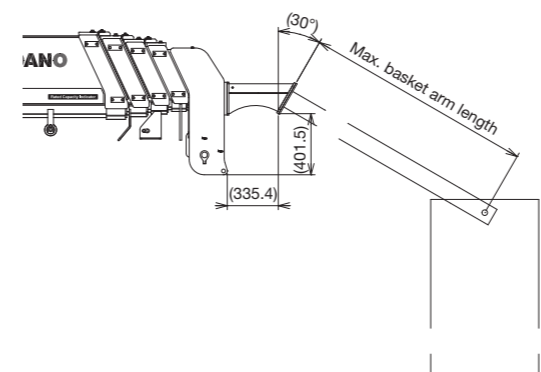

Basket mounting plate

Max. basket weight	200 kg
Max. basket loading capacity	200 kg
Max. basket arm length	1,500 mm

# TM-ZX1500HRS/HS

## Technical Specifications

Model	TM-ZX1505HRS/HS
CRANE CAPACITY	15,000 kg at 2.0 m (10 parts of line), 8,750 kg at 3.5 m (6 parts of line)
BOOM	Fully powered partly synchronized telescoping boom of heptagonal box construction with 4 sheaves at boom head
Sections	5
Length	5.3 m-18.5 m
Extending speed	13.2 m / 36 s
Elevation	Elevated by two double-acting hydraulic cylinders
Elevating range/speed	0° to 78° / 26 s
WINCH	Hydraulic motor driven spur gear speed reduction, provided with mechanical brake and cable follower
Single line pull	14.72 kN (1,500 kgf)
Single line speed	62 m/min. (at 4th layer)
Wire rope (Diameter x length)	10 mm x 107 m
Wire rope (Breaking strength)	73.5 kN {7,500 kgf}
Wire rope (Construction)	7 x 7 + 6 x Fi (29)
Hook block	9,000 kg capacity, 3 sheaves (110 kg)
HOOK BLOCK STOWING DEVICE	Mechanically stowed beneath boom top portion
SLEWING	•Hydraulic motor driven worm gear speed reduction •Continuous 360° full circle slewing on ball bearing slew ring •Automatic slewing lock
Slewing speed	1.5 min <sup>-1</sup> (rpm)
OUTRIGGERS	Hydraulically operated beams and jacks integral with crane frame
Extended width	Max. 5.8 m, Mid. 4.0 m, Min. 2.26 m (center to center), Max. 6.0 m, Mid. 4.2 m, Min. 2.46 m (outer to outer)
REAR OUTRIGGERS	Hydraulically operated jacks
Width	2.25 m (center to center), 2.40 m (outer to outer)
HYDRAULIC SYSTEM	
Hydraulic pump	Tandem gear pump
Hydraulic motors	Axial piston type for winch and slewing
Control valves	Multiple control valves with integral safety valves
Oil tank capacity	Approx. 130 liters
RADIO CONTROLLER (*1)	Model : RCS-F (with colored display), Control functions of telescoping, hoisting up and down, elevating, slewing, acceleration, Hook-in, Hook-out, horn, stop operation, and working height limit.
Frequency	40 frequencies in 433 MHz band
Operating power supply	
Transmitter	6 V DC, Dry battery R6 P (SUM-3) x 4
Control unit	24 V DC, Vehicle battery
Transmitter mass	Approx. 670 g (includes batteries)
SAFETY DEVICES	•Anti-two-block device •AML (Automatic Moment Limiter) <Load indication, Load moment ratio indication, Warning alarm Rated capacity indicator/limiter or Rated capacity indicator, Limit warning lamp, Outrigger length detector, Outrigger asymmetric extension width control> •Limit warning lamp (three-color) •WHL (Working Height Limiter) •Boom angle indicator •Over unwinding prevention •Hook safety latch •Spirit level •Jack interlock •Boom/outrigger stowing reminder alarm •Emergency stop switch •(*1) Stop switch on radio controller •Hydraulic safety valves, check valves and holding valves
OPTIONAL EQUIPMENT	•Outrigger pads •Oil cooler •Hook block - 15,000kg capacity (110kg) and boom point additional sheave (Hook block : 5 sheaves, swivel type hook with safety latch) •(*1) Basket mounting support •Maintenance valve
CRANE MASS	Approx. 5,220 kg (include rear outrigger, hydraulic oil tank and hydraulic oil except mounting parts)
SUITABLE TRUCKS	Gross vehicle weight (including crane mass) 25,000 kg min.

Note: Each operating speeds show the value when there is no load conditions and the pump delivery is the following conditions.

•36 L/min (Slewing speed)

•85 L/min (BOOM: Extending speed, Raising speed WINCH: Single line speed)

\*1 : TM-ZX1505HRS only.

## Working Range (4 parts of line)

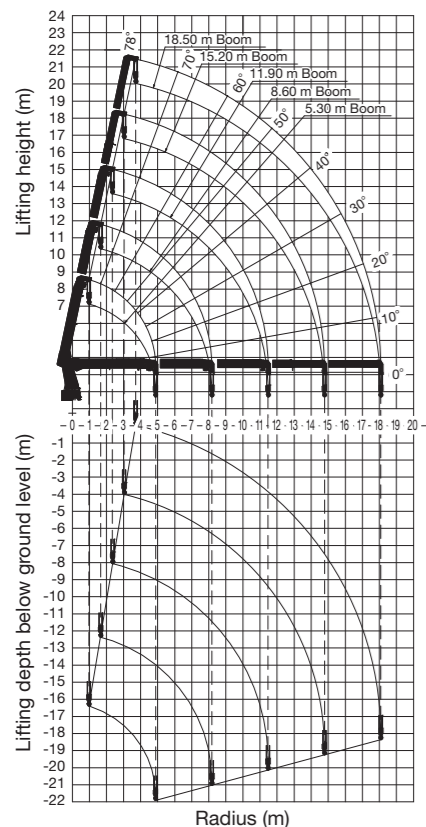

Note: The lifting heights and boom angles are based on a straight (unladen) boom, and allowance should be made for boom deflection obtained under laden conditions.

## Dimensions

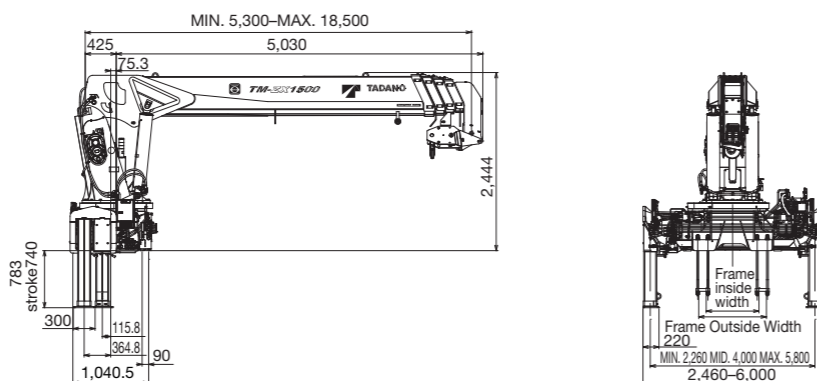

## Rated Lifting Capacities (x1,000kg)

Table A		● 5.30 m boom																				
Load radius (m)	2.0 and below	2.5	3.0	3.5	4.0	4.5	4.87															
Crane Strength	15.00	12.00	10.00	8.75	7.50	6.60	6.10															
Empty Chassis	Extension width of outriggers	Max.	15.00	12.00	10.00	8.75	7.50	6.60	6.10													
		Mid.	15.00	12.00	10.00	8.75	7.50	6.60	6.10													
		Min.	8.00	5.00	3.50	2.65	2.05	1.60	1.35													
● 8.60 m boom		● 11.90 m boom																				
Load radius (m)	3.0 and below	3.5	4.0	4.5	5.0	6.0	7.0	8.0	9.0	10.0	11.47											
Crane Strength	6.00	6.00	5.50	5.00	4.70	4.30	4.00	3.55														
Empty Chassis	Extension width of outriggers	Max.	6.00	6.00	5.50	5.00	4.70	4.30	3.15	2.25												
		Mid.	6.00	6.00	5.25	4.15	3.35	2.35	1.70	1.20												
		Min.	3.40	2.50	1.90	1.50	1.20	0.75	0.40	0.15												
● 15.20 m boom		● 18.50 m boom																				
Load radius (m)	4.0 and below	4.5	5.0	6.0	7.0	8.0	9.0	10.0	11.0	12.0	13.0	14.0	14.77									
Crane Strength	4.00	3.80	3.60	3.30	3.00	2.80	2.60	2.40	2.20	2.00	1.85	1.75	1.65									
Empty Chassis	Extension width of outriggers	Max.	4.00	3.80	3.60	3.30	3.00	2.35	1.90	1.55	1.30	1.10	0.95	0.80	0.70	0.60	0.50	0.45				
		Mid.	4.00	3.80	3.35	2.35	1.70	1.30	1.00	0.75	0.55	0.45	0.35	0.25	0.22	0.20	0.18	0.15				
		Min.	2.50	1.90	1.50	1.20	0.75	0.40	0.20	0.15												
Empty Chassis	Extension width of outriggers	Max.	3.45	3.20	2.90	2.70	2.50	2.30	2.10	1.90	1.70	1.55	1.45	1.35	1.25	1.20						
		Mid.	3.45	3.20	2.90	2.35	1.90	1.55	1.30	1.10	0.95	0.80	0.70	0.60	0.50	0.45						
		Min.	3.35	2.35	1.70	1.30	1.00	0.75	0.55	0.45	0.35	0.25	0.22	0.20	0.18	0.15						

## Table C

● 5.30 m boom		● 8.60 m boom																						
Load radius (m)	2.0 and below	2.5	3.0	3.5	4.0	4.5	4.87																	
Crane Strength	15.00	12.00	10.00	8.75	7.50	6.60	6.10																	
Empty Chassis	Extension width of outriggers	Max.	15.00	12.00	10.00	8.75	7.50	6.60	6.10															
		Mid.	15.00	12.00	10.00	8.75	7.25	5.75	4.95															
		Min.	10.60	6.75	4.80	3.65	2.90	2.30	1.95															
● 11.90 m boom		● 15.20 m boom																						
Load radius (m)	3.5 and below	4.0	4.5	5.0	6.0	7.0	8.0	9.0	10.0	11.47														
Crane Strength	4.10	4.10	4.10	3.90	3.50	3.20	3.00	2.80	2.60	2.30														
Empty Chassis	Extension width of outriggers	Max.	4.10	4.10	4.10	3.90	3.50	3.20	3.00	2.80	2.35	1.80												
		Mid.	4.10	4.10	4.10	3.90	3.35	2.50	1.90	1.60	1.30	0.95												
		Min.	3.55	2.80	2.25	1.85	1.25	0.85	0.55	0.40	0.30	-												
● 18.50 m boom		● 15.20 m boom																						
Load radius (m)	5.0 and below	6.0	7.0	8.0	9.0	10.0	11.0	12.0	13.0	14.0	15.0	16.0	17.0	18.07										
Crane Strength	3.45	3.20	2.90	2.70	2.50	2.30	2.10	1.90	1.70	1.55	1.45	1.35	1.25	1.20										
Empty Chassis	Extension width of outriggers	Max.	3.45	3.20	2.90	2.70	2.50	2.30	1.90	1.65	1.45	1.30	1.15	1.10	1.00	0.90								
		Mid.	3.45	3.20	2.50	1.90	1.60	1.30	1.00	0.85	0.75	0.65	0.55	0.50	0.45	0.40								
		Min.	3.45	3.20	2.50	1.90	1.60	1.30	1.00	0.85	0.75	0.65	0.55	0.50	0.45	0.40								

<Over-side, over-rear area>  
(Over-front area: 25% of empty chassis rated lifting capacity.)

Table B		● 5.30 m boom																					
Load radius (m)	2.0 and below	2.5	3.0	3.5	4.0	4.5	4.87																
Crane Strength	15.00	12.00	10.00	8.75	7.50	6.60	6.10																
Empty Chassis	Extension width of outriggers	Max.	15.00	12.00	10.00	8.75	7.50	6.60	6.10														
		Mid.	15.00	12.00	10.00	8.55	6.45	5.10	4.35														
		Min.	9.45	5.95	4.20	3.15	2.45	1.95	1.65														
● 8.60 m boom		● 11.90 m boom																					
Load radius (m)	3.0 and below	3.5	4.0	4.5	5.0	6.0	7.0	8.0	9.0	10.0	11.47												
Crane Strength	6.00	6.00	5.50	5.00	4.70	4.30	4.00	3.55															
Empty Chassis	Extension width of outriggers	Max.	6.00	6.00	5.50	5.00	4.70	4.30	3.85	2.85													
		Mid.	6.00	6.00	5.50	5.00	4.70	4.30	3.15	2.50													
		Min.	4.10	3.05	2.40	1.90	1.50	1.00	0.65	0.35	0.25	0.15											
● 15.20 m boom		● 18.50 m boom																					
Load radius (m)	4.0 and below	4.5	5.0	6.0	7.0	8.0	9.0	10.0	11.0	12.0	13.0	14.0	14.77										
Crane Strength	4.00	3.80	3.60	3.30	3.00	2.80	2.60	2.40	2.20	2.00	1.85	1.75	1.65										
Empty Chassis	Extension width of outriggers	Max.	4.00	3.80	3.60	3.30	3.00	2.80	2.45	2.00	1.65	1.30	1.15	1.05	1.00	0.90							
		Mid.	4.00	3.80	3.60	3.30	3.00	2.80	2.45	2.00	1.65	1.30	1.15	1.05	1.00	0.90	0.85	0.75	0.70				
		Min.	3.05	2.40	1.90	1.50	1.00	0.65	0.35	0.25	0.15	-											
Empty Chassis	Extension width of outriggers	Max.	3.45	3.20	2.90	2.70	2.50	2.30	2.10	1.90	1.70	1.55	1.45	1.35	1.25	1.20							
		Mid.	3.45	3.20	2.90	2.70	2.45	2.00	1.65	1.30	1.15	1.05	0.95	0.85	0.75	0.70							
		Min.	3.45	2.90	2.15	1.55	1.25	1.00	0.80	0.65	0.55	0.45	0.40	0.35	0.30	0.25							

- Notes:
- Rated capacity indicator issues warning with the limit warning lamp and the buzzer when the working state approaches the stability limit or the strength limit.
  - When the AML is equipped with the rated capacity limiter, an operation stops automatically if the rated lifting capacity is exceeded.
  - When the crane is front mounted, set up the front outriggers so that the front wheels are slightly in contact with the ground. (If tire deformation is large, AML may activate earlier.)
  - When the crane is front mounted, set up the rear outriggers so that the vehicle body is raised slightly with the rear wheels sufficiently in contact with the ground.
  - Empty Chassis Rated Capacities in these tables depend on condition that crane is set level on firm level ground.
  - This value has been calculated on the basis of ISO 15442.
  - This value includes the mass of lifting devices such as hook block (110 kg).
  - This load radius shows actual load radius which includes boom deflection.
  - Rated lifting capacity is in consideration of the loading on the truck bed, and is within the range from the empty chassis rated lifting capacity to the crane strength rated lifting capacity.
  - If the boom length exceeds the table value even a little, the performance is limited to the performance of the next boom length.
  - If an operation that exceeds 6,000 kg is performed, change the number of parts of line. If an operation that exceeds 9,000 kg is performed, change the hook block also to the optional 15,000 kg hook block. For details, refer to the operation manual.
- |                     |          |          |           |
|---------------------|----------|----------|-----------|
| Number of part line | 4        | 6        | 10        |
| Maximum of load     | 6,000 kg | 9,000 kg | 15,000 kg |
- Empty chassis rated lifting capacity varies according to the working area.
    - Front mounting <over-side, over-rear area> : 100%
    - <over-front area> : 25% (\*2) or 60% (\*2) or 100% (\*2)
  - \*2 : Depend on the types of chassis.
  - Empty Chassis Rated Capacities table A, B, and C depend on the types of chassis. (The following table shows guidelines for bodywork vehicles that can achieve the rated lifting capacity tables A, B, and C for vehicles with front 1-axis and rear 2-axis. Be sure to carry out a stability inspection to determine which performance to apply.)

A	5500 mm ≤ WB (*3), 25 t ≤ GVW, 3.0 t ≤ CAWF (*4), (Must be set up the rear outrigger.)
B	5500 mm ≤ WB (*3), 30 t ≤ GVW, 4.0 t ≤ CAWF (*4), (Must be set up the rear outrigger.)
C	5500 mm ≤ WB (*3), 30 t ≤ GVW, 5.0 t ≤ CAWF (*4), (Must be set up the rear outrigger.)

- \*3 : From the front axle to the farthest rear axle.
- \*4 : Chassis front axle weight (excluding crane and mounting parts mass).

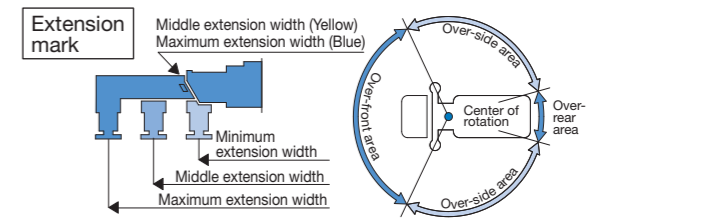

## Truck mount

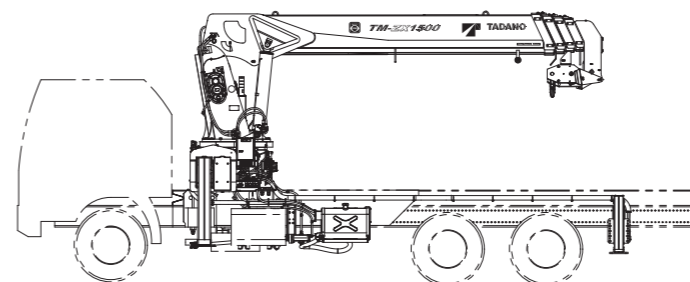

## Rear outrigger

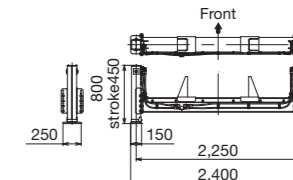

Note: Some specifications are subject to change.