

TADANO ROUGH TERRAIN CRANE
MODEL : GR-550EX
(Left-hand steering)

GENERAL DATA

<u>CRANE CAPACITY</u>		55,000 kg at 3.0 m
<u>BOOM</u>		5-section, 11.1 m — 42.0 m
<u>DIMENSION</u>		
Overall length	approx.	13,695 mm
Overall width	approx.	3,315 mm
Overall height	approx.	3,860 mm
<u>MASS</u>		
Gross vehicle mass	approx.	43,220 kg
-front axle	approx.	23,125 kg
-rear axle	approx.	20,095 kg
<u>PERFORMANCE</u>		
Max. traveling speed	computed	20 km/h
Gradeability (tan θ)	computed	153 % (at stall) *30 %

* Machine should be operated within the limit of engine crankcase design (17° : MITSUBISHI 6M60-TLU3B).

CRANE SPECIFICATIONS

<u>MODEL</u>	GR-550EX
<u>CAPACITY</u>	55,000 kg at 3.0 m
<u>BOOM</u>	<p>Five section full power partially synchronized telescoping boom of round hexagonal box construction with 5 sheaves at boom head. The synchronization system consists of 2 telescope cylinders, extension cables and retraction cables.</p> <p>Hydraulic cylinders fitted with holding valves.</p> <p>Fully retracted length. 11.1 m</p> <p>Fully extended length. 42.0 m</p> <p>Extension speed. 30.9 m in 128 s</p>
<u>JIB</u>	<p>Two staged swingaround boom extension. Triple offset (3.5°/25°/45°) type. Stores alongside base boom section.</p> <p>Assistant cylinders for mounting and stowing.</p> <p>Single sheave at jib head.</p> <p>Length. 9.9 m and 17.7 m</p>
<u>SINGLE TOP (AUXILIARY BOOM SHEAVE)</u>	<p>Single sheave.</p> <p>Mounted to main boom head for single line work.</p>
<u>ELEVATION</u>	<p>By a double-acting hydraulic cylinder, fitted with holding valve.</p> <p>Boom angle -1.4° to 80.5°</p> <p>Boom raising speed. 20° to 60° in 39 s</p>
<u>HOIST - Main winch</u>	<p>Variable speed type with grooved drum driven by hydraulic axial piston motor through winch speed reducer. Power load lowering and hoisting. Equipped with automatic brake (Neutral brake) and counterbalance valve. Controlled independently of auxiliary winch.</p> <p>Single line pull. 54.9 kN {5,600 kgf}</p> <p>Single line speed. 147 m/min (at the 4th layer)</p> <p>Wire rope. No-spin type</p> <p>Diameter x length. 19 mm x 231 m</p>
<u>HOOK BLOCK(Optional) - 55 t capacity</u>	6 sheaves, swivel type hook with safety latch.
<u>HOOK BLOCK(Optional) - 40 t capacity</u>	4 sheaves, swivel type hook with safety latch.
<u>HOOK BLOCK(Optional) - 20 t capacity</u>	2 sheaves, swivel type hook with safety latch.

<u>HOIST -</u> <u>Auxiliary winch</u>	Variable speed type with grooved drum driven by hydraulic axial piston motor through winch speed reducer. Power load lowering and hoisting. Equipped with automatic brake (Neutral brake) and counterbalance valve. Controlled independently of main winch. Single line pull. 54.9 kN {5,600 kgf} Single line speed. 126 m/min (at the 2nd layer) Wire rope. No-spin type Diameter x length. 19 mm x 129 m
<u>HOOK BLOCK -</u> <u>5.6 t capacity</u>	Swivel hook with safety latch for single line use.
<u>SWING</u>	Hydraulic axial piston motor driven through planetary speed reducer. Continuous 360° full circle swing on ball bearing slew ring. Equipped with manually locked/released swing brake. Swing speed. 2.5 min ⁻¹ {rpm}
<u>HYDRAULIC SYSTEM</u>	Pumps. 2 variable piston pumps for telescoping, elevating and winches. Tandem gear pump for steering, swing and optional equipment. Control valves. . . . Multiple valves actuated by pilot pressure with integral pressure relief valves. Circuit. Equipped with air cooled type oil cooler. Oil pressure appears on AML display for main circuit. Hydraulic oil tank capacity. . . approx. 740 liters Filters. Return line filter
<u>CRANE CONTROL</u>	By 4 control levers for swing, boom hoist, main winch, boom telescoping or auxiliary winch with 2 control pedals for boom hoist and boom telescoping based on ISO standard layout. Control lever stands can change neutral positions and tilt for easy access to cab.

CAB

Both crane and drive operations can be performed from one cab mounted on rotating superstructure. One sided one-man type, steel construction with sliding door access and tinted safety glass windows opening at side. Door window is powered control. Operator's 3 way adjustable seat with headrest and armrest. Hot water cab heater and air conditioning.

TADANO Automatic
Moment Limiter
(Model: AML-C)

Main unit in crane cab gives audible and visual warning of approach to overload. Automatically cuts out crane motions before overload. With working range (load radius and/or boom angle and/or tip height and/or swing range) limit function.

Following functions are displayed.

- Load as percentage
- Number of parts of line of rope
- Boom angle
- Boom length
- Load radius
- Outriggers position
- On-tire indicator
- Actual hook load
- Permissible load
- Boom position indicator
- Potential hook height
- Swing angle
- Main hydraulic oil pressure
- Jib length and jib offset angle (only when jib operation)

OUTRIGGERS

Hydraulically operated H-type outriggers. Each outrigger controlled simultaneously or independently from the cab.

Equipped with sight level gauge. Floats mounted integrally with the jacks retract to within vehicle width.

All cylinders fitted with pilot check valves.

Crane operation with different extended length of each outrigger.

Equipped with extension width detector for each outrigger.

Extended width

Fully. 7,200 mm

Middle. 6,700 mm

Middle. 5,500 mm

Minimum. 2,800 mm

Float size (Diameter). 500 mm

COUNTERWEIGHT

Integral with swing frame

Mass. 5,100 kg

NOTE : Each crane motion speed is based on unladen conditions.

CARRIER SPECIFICATIONS

<u>TYPE</u>	Rear engine, left-hand steering, driving axle 2-way selected type (by manual switch). 4 x 2 front drive 4 x 4 front and rear drive
<u>FRAME</u>	High-tensile steel, all welded mono-box construction.
<u>ENGINE</u>	Model. . . . MITSUBISHI 6M60-TLU3B [EUROMOT Stage IIIA] Type. . . . 4 cycle, turbo charged and after cooled, 6 cylinder in line, direct injection, water cooled diesel engine. Piston displacement. . . . 7,545 cm ³ Bore x stroke. 118 mm x 115 mm Max. output. 200 kW at 2,600 min ⁻¹ {rpm} Max. torque. 785 N-m at 1,400 min ⁻¹ {rpm}
<u>TRANSMISSION</u>	Electronically controlled full automatic transmission. Torque converter driving full powershift with driving axle selector. 6 forward and 2 reverse speeds. 2 speeds - High range - 2 wheel drive ; 4 wheel drive 3 speeds - Low range - 4 wheel drive
<u>AXLES</u>	Front. . . . Full floating type, steering and driving axle with planetary reduction. Rear. . . . Full floating type, steering and driving axle with planetary reduction. Non-spin differential.
<u>STEERING</u>	Hydraulic power steering controlled by steering wheel. Four steering modes available: 2-wheel front 2-wheel rear 4-wheel coordinated 4-wheel crab
<u>SUSPENSION</u>	Front. . . . Rigid mounted to the frame. Rear. . . . Pivot mounted with hydraulic lockout cylinders.
<u>BRAKE SYSTEM</u>	Service. . . Air over hydraulic disc brakes on all 4 wheels. Parking / Emergency. . . Spring applied-air released brake acting on input shaft of front axle. Auxiliary. . . Electro-pneumatic operated exhaust brake.
<u>ELECTRIC SYSTEM</u>	24 V DC. 2 batteries of 12 V - 120 Ah capacity.
<u>FUEL TANK CAPACITY</u>	300 liters
<u>TIRES</u>	Front.....29.5–25 22PR(OR) or 29.5–25 28PR(OR), Single x 2 Rear.....29.5–25 22PR(OR) or 29.5–25 28PR(OR), Single x 2
<u>TURN RADIUS</u>	Min. turning radius (at center of extreme outer tire) 2-wheel steering. 11.9 m 4-wheel steering. 6.7 m

EQUIPMENT

STANDARD EQUIPMENT

Automatic moment limiter (AML)
 External lamp and buzzer (AML)
 Pendant type over-winding cutout
 Winch automatic fail-safe brake
 Over-unwinding prevention
 Cable follower
 Hook safety latch
 Pilot check valves
 Holding valves
 Counterbalance valves
 Hydraulic pressure relief valves
 Swing brake
 Swing lock (360° positive swing lock)
 Boom angle indicator
 Boom elevation foot pedal
 Boom telescoping foot pedal
 Outrigger extension width detector
 Emergency engine stop system
 Hot water cab heater, air conditioner and defroster
 Outrigger control box (Both sides of carrier)
 Sight level gauge
 Hydraulic oil cooler
 Electric windshield wiper and washer
 Roof window wiper and washer
 Power window (Cab door)
 Tachometer/Speedometer
 3 way adjustable cloth seat with seat belt, headrest and armrest
 Cab floor mat
 Sun visor (Front and roof)
 Automatic drive system
 Emergency steering
 Transmission neutral position engine start
 Overshift prevention
 Parking braked travel warning
 Tilt-telescope steering wheel
 Back-up alarm
 Air cleaner dust indicator
 Air dryer
 Water separator with filter
 Engine over-run alarm
 Hydraulic lockout suspension
 Non-spin differential (Rear)
 Towing eyes - front and rear

OPTIONAL EQUIPMENT

Winch drum rotation indicator (Visual type)
 Winch drum mirror
 Electric fan
 Tire inflation kit
 Hook block - 55t capacity (6 sheaves, swivel type with safety latch.
 Mass : approx. 570 kg)
 Hook block - 40t capacity (4 sheaves, swivel type with safety latch.
 Mass : 470 kg)
 Hook block - 20t capacity (2 sheaves, swivel type with safety latch.
 Mass : 400 kg)

RATED LIFTING CAPACITIES

EN13000

ON OUTRIGGERS FULLY EXTENDED 7.2m SPREAD 360° ROTATION (Unit: x 1,000 kg)																				
A B	11.1m		15.0m		18.8m				26.6m				34.3m				38.1m		42.0m	
	C	C	C	C	C	C	C	C	C	C	C	C	C	C	C	C	C	C	C	
3.0	67.5	55.0	73.7	40.8	77.4	30.0	76.9	22.0												
3.5	64.4	53.4	71.7	40.8	75.9	30.0	75.4	22.0												
4.0	61.3	48.4	69.6	40.8	74.4	30.0	74.0	22.0	79.8	22.0	79.5	14.0								
4.5	58.3	43.8	67.5	40.8	72.8	30.0	72.3	22.0	78.7	22.0	78.4	14.0								
5.0	55.0	39.8	65.4	38.9	71.3	29.0	70.8	22.0	77.8	22.0	77.5	14.0								
5.5	51.8	36.0	63.2	35.6	69.6	27.2	69.1	22.0	76.7	21.5	76.3	13.6								
6.0	48.3	32.8	60.9	32.4	67.9	25.0	67.5	21.6	75.6	20.0	75.2	12.8	79.3	14.0	78.9	8.0				
6.5	44.5	30.1	58.7	29.7	66.2	23.4	65.8	20.8	74.5	18.9	74.2	12.0	78.5	14.0	78.1	8.0				
7.0	40.5	27.8	56.3	27.4	64.4	22.0	64.1	20.1	73.2	17.8	73.0	11.4	77.7	13.5	77.4	8.0	79.2	8.0		
8.0	31.4	23.6	51.4	23.1	60.9	19.5	60.7	18.8	71.0	15.8	70.8	10.3	76.0	12.5	75.7	8.0	77.9	8.0	79.1	8.0
9.0	15.8	17.5	46.1	18.7	57.2	17.0	56.9	17.7	68.6	14.3	68.4	9.3	74.2	11.3	74.1	7.6	76.6	8.0	77.9	8.0
10.0			40.0	15.2	53.3	14.5	53.1	16.0	66.3	13.0	66.0	8.5	72.5	10.4	72.3	7.0	75.1	7.5	76.7	8.0
11.0			33.2	12.4	49.2	12.0	48.9	14.2	63.8	11.8	63.6	7.8	70.7	9.6	70.5	6.4	73.5	6.9	75.2	7.5
12.0			24.9	10.5	44.8	10.0	44.5	12.3	61.2	10.8	61.0	7.2	68.9	8.8	68.7	5.8	71.9	6.4	73.9	6.9
13.0			10.3	8.9	39.8	8.5	39.6	10.7	58.7	9.5	58.5	6.7	67.0	8.2	66.9	5.4	70.3	5.9	72.5	6.5
14.0					34.8	7.2	34.0	9.3	55.8	8.2	55.8	6.2	65.3	7.6	64.9	4.9	68.6	5.5	71.0	6.0
15.0					28.4	6.1	27.8	8.2	53.2	7.2	53.2	5.8	63.4	7.0	63.0	4.6	67.0	5.1	69.5	5.6
16.0					20.4	5.2	20.0	7.3	50.2	6.3	50.3	5.5	61.3	6.5	61.0	4.2	65.2	4.7	67.9	5.2
17.0									47.1	5.5	47.2	5.3	59.4	6.0	59.0	3.9	63.6	4.4	66.5	4.9
18.0									43.8	4.8	44.1	5.0	57.2	5.3	57.0	3.6	61.8	4.1	64.9	4.6
19.0									40.4	4.2	40.6	4.8	55.2	4.7	54.9	3.4	60.0	3.8	63.2	4.3
20.0									36.8	3.7	36.9	4.6	53.0	4.2	52.8	3.2	58.2	3.6	61.7	4.0
22.0									28.2	2.8	28.3	3.9	48.3	3.3	48.2	2.9	54.3	3.1	58.4	3.4
24.0									15.9	2.1	15.7	3.3	43.2	2.5	43.3	2.6	50.0	2.8	54.9	2.8
26.0													37.6	1.9	37.8	2.3	45.6	2.5	51.1	2.2
28.0													31.3	1.4	31.6	2.1	40.7	2.0	47.2	1.7
30.0													23.5	1.0	23.7	1.9	35.2	1.6	43.1	1.3
32.0													11.9	0.7	11.6	1.6	29.0	1.2	38.7	0.9
34.0																	21.6	0.9		
36.0																	8.9	0.7		
D	0°																		37°	
Telescoping conditions (%)																				
Telescoping Mode	I,II	I	I	II	I	II	I	II	I	II	I	II	II	II	I,II					
2nd boom	0	50	100	0	100	0	100	0	100	0	100	0	50	100						
3rd boom	0	0	0	33	33	66	66	100	100	100										
4th boom	0	0	0	33	33	66	66	100	100	100										
Top boom	0	0	0	33	33	66	66	100	100	100										

- A :Boom length (m)
- B :Load radius (m)
- C :Loaded boom angle (°)
- D :Minimum boom angle(°)

ON OUTRIGGERS FULLY EXTENDED 7.2m SPREAD 360° ROTATION													
C	42.0m Boom + 9.9m JIB						42.0m Boom + 17.7m JIB						
	3.5° Tilt		25° Tilt		45° Tilt		3.5° Tilt		25° Tilt		45° Tilt		
	R	W	R	W	R	W	R	W	R	W	R	W	
80	9.6	4.0	13.0	3.5	14.9	3.0	12.0	2.7	18.1	2.0	22.4	1.4	
75	14.9	4.0	17.7	3.0	19.1	2.5	18.1	2.6	23.3	1.6	27.1	1.3	
70	19.3	3.1	22.1	2.4	23.2	2.1	23.2	1.9	27.9	1.3	31.2	1.1	
65	23.5	2.4	26.2	2.0	27.2	1.8	28.2	1.5	32.1	1.0	34.8	0.9	
60	27.4	2.0	29.9	1.6	30.9	1.5	32.6	1.2	36.3	0.9	38.4	0.8	
55	30.9	1.6	33.3	1.4	34.0	1.3	36.5	0.9	40.0	0.7	41.8	0.7	
50	34.0	1.0	36.2	0.9	36.7	0.9	39.9	0.5					
45	37.1	0.6	38.9	0.5	39.2	0.5							

ON OUTRIGGERS FULLY EXTENDED 7.2m SPREAD 360° ROTATION													
C	34.3m Boom (telescoping mode I) + 9.9m JIB						34.3m Boom (telescoping mode I) + 17.7m JIB						
	3.5° Tilt		25° Tilt		45° Tilt		3.5° Tilt		25° Tilt		45° Tilt		
	R	W	R	W	R	W	R	W	R	W	R	W	
80	7.6	5.6	11.4	4.7	13.7	3.4	10.1	3.6	16.3	2.4	20.3	1.6	
75	11.9	5.6	15.1	4.0	17.3	3.1	15.2	3.6	20.7	2.1	24.3	1.5	
70	15.7	4.8	18.7	3.4	20.5	2.8	19.7	3.0	24.7	1.8	27.8	1.4	
65	19.2	3.8	21.9	2.9	23.5	2.5	23.8	2.4	28.5	1.6	31.1	1.3	
60	22.5	3.2	25.1	2.5	26.3	2.3	27.7	2.0	32.0	1.4	34.1	1.2	
55	25.6	2.7	27.9	2.2	28.9	2.1	31.3	1.6	35.2	1.3	36.7	1.1	
50	28.4	2.0	30.5	1.8	31.3	1.7	34.5	1.2	38.0	1.0	39.1	1.0	
45	31.0	1.4	32.9	1.3	33.3	1.2	37.5	0.8	40.5	0.7	41.1	0.6	
40	33.4	1.0	35.0	0.9			40.3	0.5					
35	35.7	0.7	36.9	0.6									

ON OUTRIGGERS FULLY EXTENDED 7.2m SPREAD 360° ROTATION													
C	38.1m Boom (telescoping mode II) + 9.9m JIB						38.1m Boom (telescoping mode II) + 17.7m JIB						
	3.5° Tilt		25° Tilt		45° Tilt		3.5° Tilt		25° Tilt		45° Tilt		
	R	W	R	W	R	W	R	W	R	W	R	W	
80	8.9	4.5	12.7	4.1	14.8	3.1	10.9	2.8	17.7	2.2	21.7	1.5	
75	13.8	4.5	16.7	3.2	18.6	2.6	16.6	2.8	22.3	1.8	25.9	1.3	
70	17.7	3.4	20.6	2.6	22.2	2.2	21.3	2.1	26.5	1.4	29.7	1.1	
65	21.5	2.6	24.2	2.1	25.6	1.8	25.8	1.6	30.5	1.1	33.3	1.0	
60	25.1	2.1	27.6	1.7	28.8	1.6	30.0	1.3	34.3	0.9	36.4	0.8	
55	28.4	1.7	30.8	1.5	31.7	1.4	33.9	1.0	37.8	0.8	39.3	0.7	
50	31.5	1.4	33.6	1.3	34.2	1.2	37.6	0.8	41.0	0.7	42.0	0.6	
45	34.4	1.2	36.2	1.1	36.5	1.0	41.1	0.6	43.9	0.6	44.5	0.5	
40	36.9	0.8	38.5	0.8									
35	39.3	0.5	40.6	0.5									

C : Boom angle (°)

R : Load radius (m)

W : Rated lifting capacity (Unit : x1,000kg)

ON OUTRIGGERS MID EXTENDED 6.7m SPREAD																				
360° ROTATION (Unit: x 1,000 kg)																				
B \ A	11.1m		15.0m		18.8m				26.6m				34.3m				38.1m		42.0m	
	C		C		C		C		C		C		C		C		C			
3.0	67.5	55.0	73.7	40.8	77.4	30.0	76.9	22.0												
3.5	64.4	53.4	71.7	40.8	75.9	30.0	75.4	22.0												
4.0	61.3	48.4	69.6	40.8	74.4	30.0	74.0	22.0	79.8	22.0	79.5	14.0								
4.5	58.3	43.8	67.5	40.8	72.8	30.0	72.3	22.0	78.7	22.0	78.4	14.0								
5.0	55.0	39.8	65.4	38.9	71.3	29.0	70.8	22.0	77.8	22.0	77.5	14.0								
5.5	51.8	36.0	63.2	35.6	69.6	27.2	69.1	22.0	76.7	21.5	76.3	13.6								
6.0	48.3	32.8	60.9	32.4	67.9	25.0	67.5	21.6	75.6	20.0	75.2	12.8	79.3	14.0	78.9	8.0				
6.5	44.5	30.1	58.7	29.7	66.2	23.4	65.8	20.8	74.5	18.9	74.2	12.0	78.5	14.0	78.1	8.0				
7.0	40.5	27.2	56.3	26.3	64.4	22.0	64.1	20.1	73.2	17.8	73.0	11.4	77.7	13.5	77.4	8.0	79.2	8.0		
8.0	31.1	20.7	51.4	20.2	60.7	19.4	60.7	18.8	71.0	15.8	70.8	10.3	76.0	12.5	75.7	8.0	77.9	8.0	79.1	8.0
9.0	15.4	15.8	46.1	16.0	57.1	15.6	56.9	17.7	68.6	14.3	68.4	9.3	74.2	11.3	74.1	7.6	76.6	8.0	77.9	8.0
10.0			40.0	13.0	53.2	12.7	53.1	15.3	66.3	13.0	66.0	8.5	72.5	10.4	72.3	7.0	75.1	7.5	76.7	8.0
11.0			33.2	11.0	48.9	10.5	48.9	12.7	63.8	11.5	63.6	7.8	70.7	9.6	70.5	6.4	73.5	6.9	75.2	7.5
12.0			24.9	9.2	44.7	8.7	44.5	11.0	61.2	10.0	61.0	7.2	68.9	8.8	68.7	5.8	71.9	6.4	73.9	6.9
13.0			10.3	7.6	39.5	7.2	39.6	9.4	58.5	8.5	58.5	6.7	67.0	8.2	66.9	5.4	70.3	5.9	72.5	6.5
14.0					34.3	6.0	34.0	8.2	55.8	7.3	55.8	6.2	65.3	7.6	64.9	4.9	68.6	5.5	71.0	6.0
15.0					28.2	5.0	27.8	7.4	53.0	6.4	53.2	5.8	63.3	6.8	63.0	4.6	67.0	5.1	69.5	5.6
16.0					20.2	4.2	20.0	6.5	50.1	5.6	50.3	5.5	61.3	6.0	61.0	4.2	65.2	4.7	67.9	5.2
17.0									47.0	4.8	47.2	5.3	59.1	5.2	59.0	3.9	63.6	4.4	66.5	4.9
18.0									43.7	4.2	44.1	5.0	57.2	4.6	57.0	3.6	61.8	4.1	64.9	4.6
19.0									40.3	3.6	40.6	4.8	54.9	4.0	54.9	3.4	60.0	3.8	63.2	4.3
20.0									36.6	3.1	36.9	4.3	52.8	3.5	52.8	3.2	58.2	3.6	61.7	3.9
22.0									27.8	2.3	28.1	3.4	48.1	2.8	48.2	2.9	54.3	3.1	58.3	3.1
24.0									15.3	1.7	15.4	2.7	43.0	2.0	43.3	2.6	50.0	2.6	54.6	2.4
26.0													37.5	1.5	37.8	2.3	45.6	2.1	51.0	1.8
28.0													31.1	1.0	31.6	2.1	40.7	1.6	47.1	1.4
30.0													23.4	0.7	23.7	1.6	35.2	1.2	43.0	1.0
32.0															11.6	1.3	29.0	0.9		
D	0°												19°		0°		22°		38°	
Telescoping conditions (%)																				
Telescoping Mode	I,II	I	I	II	I	II	I	II	I	II	I	II	I	II	I,II					
2nd boom	0	50	100	0	100	0	100	0	100	0	100	0	50	100						
3rd boom	0	0	0	33	33	66	66	100	100	100	100	100	100	100						
4th boom	0	0	0	33	33	66	66	100	100	100	100	100	100	100						
Top boom	0	0	0	33	33	66	66	100	100	100	100	100	100	100						

A :Boom length (m)
 B :Load radius (m)
 C :Loaded boom angle (°)
 D :Minimum boom angle(°)

ON OUTRIGGERS MID EXTENDED 6.7m SPREAD 360° ROTATION												
C	42.0m Boom + 9.9m JIB						42.0m Boom + 17.7m JIB					
	3.5° Tilt		25° Tilt		45° Tilt		3.5° Tilt		25° Tilt		45° Tilt	
	R	W	R	W	R	W	R	W	R	W	R	W
80	9.6	4.0	13.0	3.5	14.9	3.0	12.0	2.7	18.1	2.0	22.4	1.4
75	14.9	4.0	17.7	3.0	19.1	2.5	18.1	2.6	23.3	1.6	27.1	1.3
70	19.3	3.1	22.1	2.4	23.2	2.1	23.2	1.9	27.9	1.3	31.2	1.1
65	23.5	2.4	26.2	2.0	27.2	1.8	28.2	1.5	32.1	1.0	34.8	0.9
60	27.4	2.0	29.9	1.6	30.9	1.5	32.6	1.2	36.3	0.9	38.4	0.8
55	30.7	1.3	33.2	1.2	33.9	1.1	36.3	0.7	39.8	0.5	41.6	0.5
50	33.9	0.8	36.1	0.7	36.6	0.7						

ON OUTRIGGERS MID EXTENDED 6.7m SPREAD 360° ROTATION												
C	34.3m Boom (telescoping mode I) + 9.9m JIB						34.3m Boom (telescoping mode I) + 17.7m JIB					
	3.5° Tilt		25° Tilt		45° Tilt		3.5° Tilt		25° Tilt		45° Tilt	
	R	W	R	W	R	W	R	W	R	W	R	W
80	7.6	5.6	11.4	4.7	13.7	3.4	10.1	3.6	16.3	2.4	20.3	1.6
75	11.9	5.6	15.1	4.0	17.3	3.1	15.2	3.6	20.7	2.1	24.3	1.5
70	15.7	4.8	18.7	3.4	20.5	2.8	19.7	3.0	24.7	1.8	27.8	1.4
65	19.2	3.8	21.9	2.9	23.5	2.5	23.8	2.4	28.5	1.6	31.1	1.3
60	22.5	3.2	25.1	2.5	26.3	2.3	27.7	2.0	32.0	1.4	34.1	1.2
55	25.6	2.4	27.9	2.1	28.9	2.0	31.3	1.6	35.2	1.3	36.7	1.1
50	28.3	1.6	30.5	1.5	31.2	1.4	34.5	1.0	37.9	0.8	39.0	0.7
45	31.0	1.1	32.8	1.0	33.3	1.0	37.5	0.6	40.4	0.5		
40	33.3	0.7	34.9	0.6								

ON OUTRIGGERS MID EXTENDED 6.7m SPREAD 360° ROTATION												
C	38.1m Boom (telescoping mode II) + 9.9m JIB						38.1m Boom (telescoping mode II) + 17.7m JIB					
	3.5° Tilt		25° Tilt		45° Tilt		3.5° Tilt		25° Tilt		45° Tilt	
	R	W	R	W	R	W	R	W	R	W	R	W
80	8.9	4.5	12.7	4.1	14.8	3.1	10.9	2.8	17.7	2.2	21.7	1.5
75	13.8	4.5	16.7	3.2	18.6	2.6	16.6	2.8	22.3	1.8	25.9	1.3
70	17.7	3.4	20.6	2.6	22.2	2.2	21.3	2.1	26.5	1.4	29.7	1.1
65	21.5	2.6	24.2	2.1	25.6	1.8	25.8	1.6	30.5	1.1	33.3	1.0
60	25.1	2.1	27.6	1.7	28.8	1.6	30.0	1.3	34.3	0.9	36.4	0.8
55	28.4	1.7	30.8	1.5	31.7	1.4	33.9	1.0	37.8	0.8	39.3	0.7
50	31.5	1.4	33.6	1.3	34.2	1.2	37.6	0.8	41.0	0.7	42.0	0.6
45	34.3	0.9	36.1	0.8	36.4	0.8						
40	36.8	0.5	38.3	0.5								

C : Boom angle (°)

R : Load radius (m)

W : Rated lifting capacity (Unit : x1,000kg)

ON OUTRIGGERS MID EXTENDED 5.5m SPREAD																						
360° ROTATION (Unit: x 1,000 kg)																						
A \ B	11.1m		15.0m		18.8m				26.6m				34.3m				38.1m		42.0m			
	C		C		C	C		C	C		C	C		C	C		C	C				
3.0	67.5	55.0	73.7	40.8	77.4	30.0	76.9	22.0														
3.5	64.4	53.4	71.7	40.8	75.9	30.0	75.4	22.0														
4.0	61.3	48.4	69.6	40.8	74.4	30.0	74.0	22.0	79.8	22.0	79.5	14.0										
4.5	58.3	43.8	67.5	39.0	72.8	30.0	72.3	22.0	78.7	22.0	78.4	14.0										
5.0	55.0	37.6	65.4	32.7	71.3	29.0	70.8	22.0	77.8	22.0	77.5	14.0										
5.5	51.8	30.5	63.2	28.0	69.6	25.1	69.1	22.0	76.7	21.5	76.3	13.6										
6.0	48.3	26.0	60.9	24.3	67.9	21.9	67.5	21.6	75.6	20.0	75.2	12.8	79.3	14.0	78.9	8.0						
6.5	44.5	22.0	58.5	21.4	66.2	19.4	65.8	20.8	74.5	18.3	74.2	12.0	78.5	14.0	78.1	8.0						
7.0	40.5	19.4	56.2	18.6	64.4	17.2	64.1	20.1	73.2	16.5	73.0	11.4	77.7	13.5	77.4	8.0	79.2	8.0				
8.0	31.1	15.0	51.3	14.5	60.7	13.6	60.5	16.5	70.9	13.7	70.8	10.3	76.0	12.5	75.7	8.0	77.9	8.0	79.1	8.0		
9.0	15.2	11.6	45.9	11.5	56.9	11.0	56.8	13.3	68.4	11.5	68.4	9.3	74.2	11.1	74.1	7.6	76.6	8.0	77.9	8.0		
10.0			40.0	9.3	53.1	9.0	52.9	11.1	65.9	9.8	66.0	8.5	72.4	9.5	72.3	7.0	75.1	7.5	76.7	8.0		
11.0			33.2	7.7	48.9	7.3	48.8	9.3	63.5	8.4	63.6	7.8	70.6	8.3	70.5	6.4	73.5	6.9	75.2	7.5		
12.0			24.9	6.4	44.6	6.0	44.3	7.9	60.9	7.1	61.0	7.2	68.7	7.2	68.7	5.8	71.9	6.4	73.9	6.9		
13.0			10.3	5.3	39.5	4.8	39.6	6.8	58.3	6.1	58.5	6.7	66.8	6.4	66.9	5.4	70.3	5.9	72.4	6.3		
14.0					34.3	3.9	33.9	5.9	55.5	5.2	55.8	6.2	64.8	5.6	64.9	4.9	68.6	5.5	70.8	5.6		
15.0					28.2	3.2	27.8	5.1	52.8	4.4	53.0	5.6	63.0	4.9	63.0	4.6	67.0	5.1	69.3	4.9		
16.0					20.2	2.5	19.8	4.3	49.8	3.7	50.2	4.9	60.9	4.2	61.0	4.2	65.2	4.7	67.6	4.4		
17.0									46.7	3.1	46.9	4.3	58.9	3.6	59.0	3.9	63.5	4.2	66.0	3.9		
18.0									43.5	2.6	43.7	3.8	56.8	3.1	57.0	3.6	61.6	3.7	64.4	3.4		
19.0									40.0	2.1	40.4	3.3	54.8	2.6	54.9	3.4	59.7	3.2	62.8	3.0		
20.0									36.2	1.7	36.6	2.9	52.4	2.2	52.8	3.2	57.8	2.8	61.1	2.6		
22.0									27.7	1.1	27.9	2.2	47.8	1.5	48.1	2.5	53.8	2.1	57.7	1.9		
24.0											15.3	1.7	42.7	1.0	43.1	2.0	49.6	1.6	54.2	1.4		
26.0															37.6	1.5	45.1	1.2	50.5	0.9		
28.0															31.3	1.1	40.3	0.8				
30.0															23.4	0.8						
D	0°				13°				0°				38°				19°		37°		47°	
Telescoping conditions (%)																						
Telescoping Mode	I,II	I	I	II	I	II	I	II	I	II	I	II	II	II	I,II							
2nd boom	0	50	100	0	100	0	100	0	100	0	100	0	50	100								
3rd boom	0	0	0	33	33	66	66	100	100	100	100	100	100	100								
4th boom	0	0	0	33	33	66	66	100	100	100	100	100	100	100								
Top boom	0	0	0	33	33	66	66	100	100	100	100	100	100	100								

A :Boom length (m)
 B :Load radius (m)
 C :Loaded boom angle (°)
 D :Minimum boom angle(°)

ON OUTRIGGERS MID EXTENDED 5.5m SPREAD 360° ROTATION												
C	42.0m Boom + 9.9m JIB						42.0m Boom + 17.7m JIB					
	3.5° Tilt		25° Tilt		45° Tilt		3.5° Tilt		25° Tilt		45° Tilt	
	R	W	R	W	R	W	R	W	R	W	R	W
80	9.6	4.0	13.0	3.5	14.9	3.0	12.0	2.7	18.1	2.0	22.4	1.4
75	14.9	4.0	17.7	3.0	19.1	2.5	18.1	2.6	23.3	1.6	27.1	1.3
70	19.3	3.1	22.1	2.4	23.2	2.1	23.2	1.9	27.9	1.3	31.2	1.1
65	23.2	2.1	25.9	1.7	27.1	1.6	27.9	1.3	32.1	1.0	34.8	0.8
60	26.8	1.2	29.5	1.0	30.5	0.9	31.7	0.5				
55	30.2	0.5	32.7	0.5								

ON OUTRIGGERS MID EXTENDED 5.5m SPREAD 360° ROTATION												
C	34.3m Boom (telescoping mode I) + 9.9m JIB						34.3m Boom (telescoping mode I) + 17.7m JIB					
	3.5° Tilt		25° Tilt		45° Tilt		3.5° Tilt		25° Tilt		45° Tilt	
	R	W	R	W	R	W	R	W	R	W	R	W
80	7.6	5.6	11.4	4.7	13.7	3.4	10.1	3.6	16.3	2.4	20.3	1.6
75	11.9	5.6	15.1	4.0	17.3	3.1	15.2	3.6	20.7	2.1	24.3	1.5
70	15.7	4.8	18.7	3.4	20.5	2.8	19.7	3.0	24.7	1.8	27.8	1.4
65	19.1	3.5	21.9	2.9	23.5	2.5	23.8	2.4	28.5	1.6	31.1	1.3
60	22.2	2.3	24.8	1.9	26.2	1.8	27.3	1.4	31.8	1.1	33.9	0.9
55	25.3	1.4	27.6	1.2	28.7	1.1	30.6	0.8	34.7	0.6	36.5	0.5
50	28.1	0.8	30.2	0.7	31.0	0.6						

ON OUTRIGGERS MID EXTENDED 5.5m SPREAD 360° ROTATION												
C	38.1m Boom (telescoping mode II) + 9.9m JIB						38.1m Boom (telescoping mode II) + 17.7m JIB					
	3.5° Tilt		25° Tilt		45° Tilt		3.5° Tilt		25° Tilt		45° Tilt	
	R	W	R	W	R	W	R	W	R	W	R	W
80	8.9	4.5	12.7	4.1	14.8	3.1	10.9	2.8	17.7	2.2	21.7	1.5
75	13.8	4.5	16.7	3.2	18.6	2.6	16.6	2.8	22.3	1.8	25.9	1.3
70	17.7	3.4	20.6	2.6	22.2	2.2	21.3	2.1	26.5	1.4	29.7	1.1
65	21.5	2.6	24.2	2.1	25.6	1.8	25.8	1.6	30.5	1.1	33.3	1.0
60	25.1	2.0	27.6	1.7	28.8	1.6	29.7	1.2	34.3	0.9	36.4	0.8
55	28.2	1.2	30.5	1.1	31.4	1.0	33.3	0.6	37.5	0.5	39.2	0.5
50	31.0	0.6	33.2	0.6	33.9	0.6						

C : Boom angle (°)

R : Load radius (m)

W : Rated lifting capacity (Unit : x1,000kg)

ON OUTRIGGERS MIN EXTENDED 2.8m SPREAD																				
360° ROTATION (Unit: x 1,000 kg)																				
A \ B	11.1m		15.0m		18.8m				26.6m				34.3m				38.1m		42.0m	
	C		C		C		C		C		C		C		C		C			
3.0	67.2	27.6	73.5	23.4	77.1	20.3	76.9	22.0												
3.5	64.1	22.4	71.5	19.2	75.5	16.8	75.3	19.6												
4.0	61.2	18.6	69.3	16.0	73.9	14.1	73.7	16.8	79.3	13.1	79.5	14.0								
4.5	58.2	15.5	67.2	13.6	72.3	12.0	72.1	14.6	78.2	11.4	78.4	13.2								
5.0	55.0	13.2	65.1	11.7	70.7	10.3	70.5	12.8	77.0	10.0	77.2	11.7								
5.5	51.6	11.0	62.9	10.1	69.1	8.9	68.9	11.3	76.0	8.8	76.0	10.5								
6.0	48.1	9.5	60.7	8.8	67.4	7.8	67.2	10.1	74.8	7.8	74.9	9.4	78.8	7.5	78.9	8.0				
6.5	44.4	8.0	58.4	7.7	65.7	6.8	65.5	9.1	73.7	7.0	73.8	8.5	77.9	6.7	78.1	7.9				
7.0	40.2	7.0	56.0	6.8	64.1	5.9	63.8	8.2	72.6	6.2	72.6	7.8	77.0	6.1	77.2	7.2	79.0	6.5		
8.0	30.6	5.3	51.2	5.1	60.6	4.5	60.3	6.7	70.3	5.0	70.3	6.5	75.3	4.9	75.5	6.1	77.4	5.4	78.5	4.8
9.0	15.2	4.0	45.9	3.7	56.8	3.4	56.6	5.4	67.8	4.0	67.9	5.5	73.6	4.1	73.7	5.2	75.8	4.5	77.1	4.0
10.0			39.9	2.7	52.9	2.4	52.7	4.3	65.3	3.2	65.5	4.6	71.8	3.3	71.9	4.4	74.3	3.8	75.7	3.3
11.0			32.9	1.8	48.8	1.6	48.7	3.4	63.0	2.5	62.9	3.9	70.0	2.7	70.1	3.8	72.5	3.2	74.4	2.7
12.0			24.5	1.1	44.5	0.9	44.0	2.7	60.5	1.9	60.4	3.2	68.2	2.2	68.3	3.3	70.9	2.7	73.0	2.3
13.0							39.2	2.1	57.9	1.4	57.8	2.6	66.4	1.7	66.3	2.8	69.2	2.3	71.6	1.8
14.0							33.6	1.6	55.1	1.0	55.0	2.1	64.6	1.3	64.5	2.4	67.4	1.9	70.3	1.5
15.0							27.5	1.2			52.2	1.7	62.6	1.0	62.5	1.9	65.8	1.6	68.9	1.2
16.0							19.3	0.8			49.4	1.3	60.5	0.7	60.5	1.6	64.1	1.3	67.5	0.9
17.0											46.4	1.2			58.6	1.3	62.2	1.0		
18.0											43.1	0.7			56.4	1.0	60.3	0.7		
19.0															54.2	0.7				
D	0°		12°		42°		10°		52°		41°		60°		54°		59°		66°	
Telescoping conditions (%)																				
Telescoping Mode	I,II		I		I		II		I		II		I		II		II		I,II	
2nd boom	0		50		100		0		100		0		100		0		50		100	
3rd boom	0		0		0		33		33		66		66		100		100		100	
4th boom	0		0		0		33		33		66		66		100		100		100	
Top boom	0		0		0		33		33		66		66		100		100		100	

A :Boom length (m)

B :Load radius (m)

C :Loaded boom angle (°)

D :Minimum boom angle(°)

NOTES FOR "ON OUTRIGGERS" TABLE

1. Rated lifting capacities shown in the table are based on condition that crane is set on firm level surface. Those above bold lines are based on crane strength and those below, on its stability.
2. Rated lifting capacities are according to EN13000.
3. The mass of the hook (570 kg for 55 t capacity, 470 kg for 40 t capacity, 400 kg for 20 t capacity, 150 kg for 5.6 t capacity), slings and all similarly used load handling devices must be considered as part of the load and must be deducted from the lifting capacities.
4. For rated lifting capacity of single top, reduce the rated lifting capacities of relevant boom according to a weight reduction for auxiliary load handling equipment. Capacities of single top shall not exceed 5,600 kg including main hook.
5. Standard number of parts of line for each boom length is as shown below. Load per line should not surpass 54.9 kN {5,600 kgf} for main winch and auxiliary winch.

Boom length	11.1m	11.1m to 15.0m	15.0m to 18.8m	18.8m to 42.0m	Single top Jib
Number of parts of line	11	8	6	4	1

The lifting capacity data stored in the AUTOMATIC MOMENT LIMITER (AML) is based on the standard number of parts of line listed in the chart.

Maximum lifting capacity is restricted by the number of parts of line of AUTOMATIC MOMENT LIMITER (AML).

6. The lifting capacity for over-side area differs depending on the outrigger extension width. Work with the capacity corresponding to the extension width. The lifting capacities for over-front and over-rear areas are for "outriggers fully extended". However, the areas (angle **a**) differ depending on the outrigger extension width.

Outriggers extended width	6.7m (middle)	5.5m (middle)	2.8m (minimum)
Angle a °	45	15	5

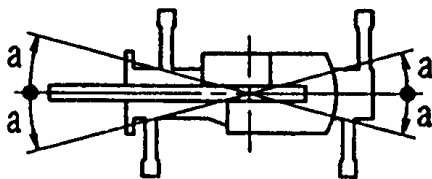

RATED LIFTING CAPACITIES

EN13000

ON RUBBER STATIONARY (Unit x 1,000kg)																
A B	Over Front								360° Rotation							
	11.1m		15.0m		18.8m		26.6m		11.1m		15.0m		18.8m		26.6m	
	C		C		C		C		C		C		C		C	
3.0	67.2	29.5	73.4	22.0					67.2	17.7	73.4	16.3				
3.5	64.3	27.2	71.4	22.0					64.3	14.8	71.4	14.2				
4.0	61.3	24.6	69.3	20.5	73.7	15.5			61.3	12.5	69.3	12.1	73.7	9.8		
4.5	58.3	22.2	67.2	19.6	72.1	15.5			58.3	10.6	67.2	10.1	72.1	9.8		
5.0	55.0	20.0	65.1	18.2	70.5	15.0			55.0	9.1	65.1	8.7	70.5	8.6		
5.5	51.7	17.5	63.0	16.4	68.8	14.4			51.7	7.7	63.0	7.5	68.8	7.3		
6.0	48.1	15.3	60.7	14.3	67.2	13.7	74.9	9.4	48.1	6.6	60.7	6.3	67.2	6.1	74.9	6.7
6.5	44.4	13.5	58.4	12.6	65.5	12.8	73.9	9.4	44.4	5.6	58.4	5.3	65.5	5.2	73.9	5.8
7.0	40.4	11.9	56.0	11.1	63.8	11.2	72.8	9.4	40.4	4.8	56.0	4.5	63.8	4.4	72.8	5.2
8.0	30.7	9.3	51.1	8.7	60.2	8.7	70.6	9.0	30.7	3.6	51.1	3.2	60.2	3.2	70.6	4.1
9.0	15.3	7.6	45.7	7.0	56.6	6.8	68.2	7.8	15.3	2.6	45.7	2.2	56.6	2.1	68.2	3.0
10.0			39.8	5.6	52.7	5.5	65.6	6.5			39.8	1.4	52.7	1.3	65.6	2.2
11.0			32.7	4.7	48.6	4.5	63.2	5.3			32.7	0.8	48.6	0.6	62.6	1.5
12.0			24.4	3.8	44.1	3.6	60.6	4.5							60.1	1.0
13.0			10.4	3.0	39.3	2.8	58.0	3.8								
14.0					33.6	2.2	55.3	3.2								
15.0					27.7	1.6	52.5	2.7								
16.0					19.1	1.0	49.6	2.2								
17.0							46.4	1.8								
18.0							43.1	1.4								
19.0							39.7	1.1								
20.0							36.0	0.8								
D	0°				32°				0°		29°		48°		58°	
Telescoping conditions (%)																
Telescoping Mode	I,II	I	II	I	II	I	II	I,II	I	II	I	II	I	II		
2nd boom	0	50	0	100	0	100	0	0	50	0	100	0	100	0		
3rd boom	0	0	16	0	33	33	66	0	0	16	0	33	33	66		
4th boom	0	0	16	0	33	33	66	0	0	16	0	33	33	66		
Top boom	0	0	16	0	33	33	66	0	0	16	0	33	33	66		

A :Boom length (m)

B :Load radius (m)

C :Loaded boom angle (°)

D :Minimum boom angle(°)

ON RUBBER CREEP (Unit x 1,000kg)																
A \ B	Over Front								360° Rotation							
	11.1m		15.0m		18.8m		26.6m		11.1m		15.0m		18.8m		26.6m	
	C		C		C		C		C		C		C		C	
3.0	67.2	22.7	73.4	21.3					67.2	17.0	73.4	16.3				
3.5	64.3	20.2	71.4	19.2					64.3	14.8	71.4	14.2				
4.0	61.3	18.2	69.3	17.3	73.7	15.0			61.3	12.2	69.3	11.7	73.7	9.8		
4.5	58.3	16.5	67.2	15.8	72.1	15.0			58.3	10.0	67.2	9.6	72.1	9.3		
5.0	55.0	15.1	65.1	14.4	70.5	14.1			55.0	8.2	65.1	8.0	70.5	7.7		
5.5	51.7	13.6	63.0	13.2	68.8	13.0			51.7	7.0	63.0	6.6	68.8	6.4		
6.0	48.1	12.4	60.7	12.0	67.2	11.9	74.9	9.4	48.1	5.9	60.7	5.5	67.2	5.4	74.7	6.4
6.5	44.4	11.4	58.4	11.0	65.5	11.0	73.9	9.4	44.4	5.0	58.4	4.7	65.5	4.6	73.5	5.5
7.0	40.4	10.5	56.0	10.1	63.8	10.1	72.8	9.4	40.4	4.3	56.0	4.1	63.8	3.8	72.4	4.8
8.0	30.7	8.5	51.1	8.1	60.2	7.9	70.6	8.6	30.7	3.1	51.1	2.8	60.2	2.7	70.0	3.6
9.0	15.3	6.7	45.7	6.3	56.6	6.2	68.2	7.2	15.7	2.2	45.7	1.9	56.6	1.7	67.5	2.7
10.0			39.8	5.1	52.7	4.9	65.6	5.9			39.8	1.2	52.7	1.1	65.1	1.9
11.0			32.7	4.1	48.6	3.9	63.2	4.9							62.6	1.3
12.0			24.4	3.3	44.1	3.1	60.6	4.0							60.1	0.8
13.0			10.4	2.6	39.3	2.4	58.0	3.3								
14.0					33.6	1.8	55.3	2.7								
15.0					27.7	1.3	52.5	2.2								
16.0					19.1	0.9	49.6	1.8								
17.0							46.4	1.4								
18.0							43.1	1.0								
19.0							39.7	0.8								
D	0°				36°				0°		34°		50°		59°	
Telescoping conditions (%)																
Telescoping Mode	I,II	I	II	I	II	I	II	I,II	I	II	I	II	I	II		
2nd boom	0	50	0	100	0	100	0	0	50	0	100	0	100	0		
3rd boom	0	0	16	0	33	33	66	0	0	16	0	33	33	66		
4th boom	0	0	16	0	33	33	66	0	0	16	0	33	33	66		
Top boom	0	0	16	0	33	33	66	0	0	16	0	33	33	66		

A :Boom length (m)
 B :Load radius (m)
 C :Loaded boom angle (°)
 D :Minimum boom angle(°)

NOTES FOR "ON RUBBER" TABLES

1. Rated lifting capacities shown in the table are based on condition that crane is set on firm level surface, with suspension lock applied. Those above bold lines are based on tire capacity and those below, on crane stability. They are based on actual working radii increased by tire deformation and boom deflection.
2. Rated lifting capacities are according to EN13000.
3. The mass of the hook (570 kg for 55t capacity, 470 kg for 40t capacity, 400 kg for 20t capacity, 150 kg for 5.6t capacity), slings and all similarly used load handling devices must be considered as part of the load and must be deducted from the lifting capacities.
4. For rated lifting capacity of single top, reduce the rated lifting capacities of relevant boom according to weight reductions for auxiliary load handling equipment. Capacities of single top shall not exceed 5,600 kg including main hook.
5. On tires lifting with "jib" is not permitted. Maximum permissible boom length is 26.6 m.
6. CREEP is motion for crane not to travel more than 60 m in any 30 minute period and to travel at the speed of less than 1.6 km/h.
7. During "CREEP" duties travel slowly and keep the lifting load as close to the ground as possible, and especially avoid any abrupt steering, accelerating or braking.
8. Do not operate the crane while carrying the load.
9. Tires should be inflated to their correct air pressure.

Tires	Air pressure
29.5-25 22PR	420 kPa (4.2kgf/cm ²)
29.5-25 28PR	450 kPa (4.5kgf/cm ²)

10. For CREEP operation, set Drive select switch to "4-WHEEL(Lo)" and set gear shift lever to "1".
11. Standard number of parts of line for on tires operation should be according to the following table.

Load per line should not surpass 54.9 kN {5,600 kgf} for main winch and auxiliary winch.

Boom length	Over Front			360° Rotation		
	11.1m	11.1m to 26.6m	Single top	11.1m	11.1m to 26.6m	Single top
Number of parts of line	6	4	1	4	4	1

The lifting capacity data stored in the AUTOMATIC MOMENT LIMITER (AML) is based on the standard number of parts of line listed in the chart.

Maximum lifting capacity is restricted by the number of parts of line of AUTOMATIC MOMENT LIMITER (AML).

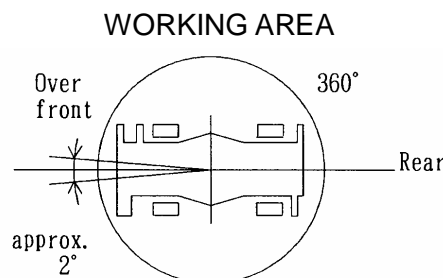

Without outriggers "Over front" operation should be performed within 2 degrees in front of chassis.

WORKING RANGE

Telescoping mode I

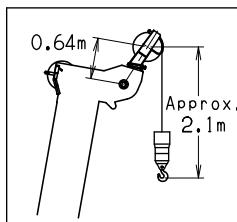
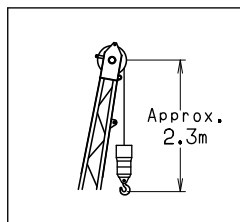
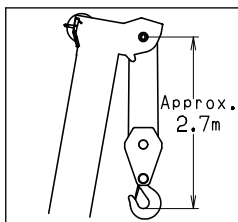
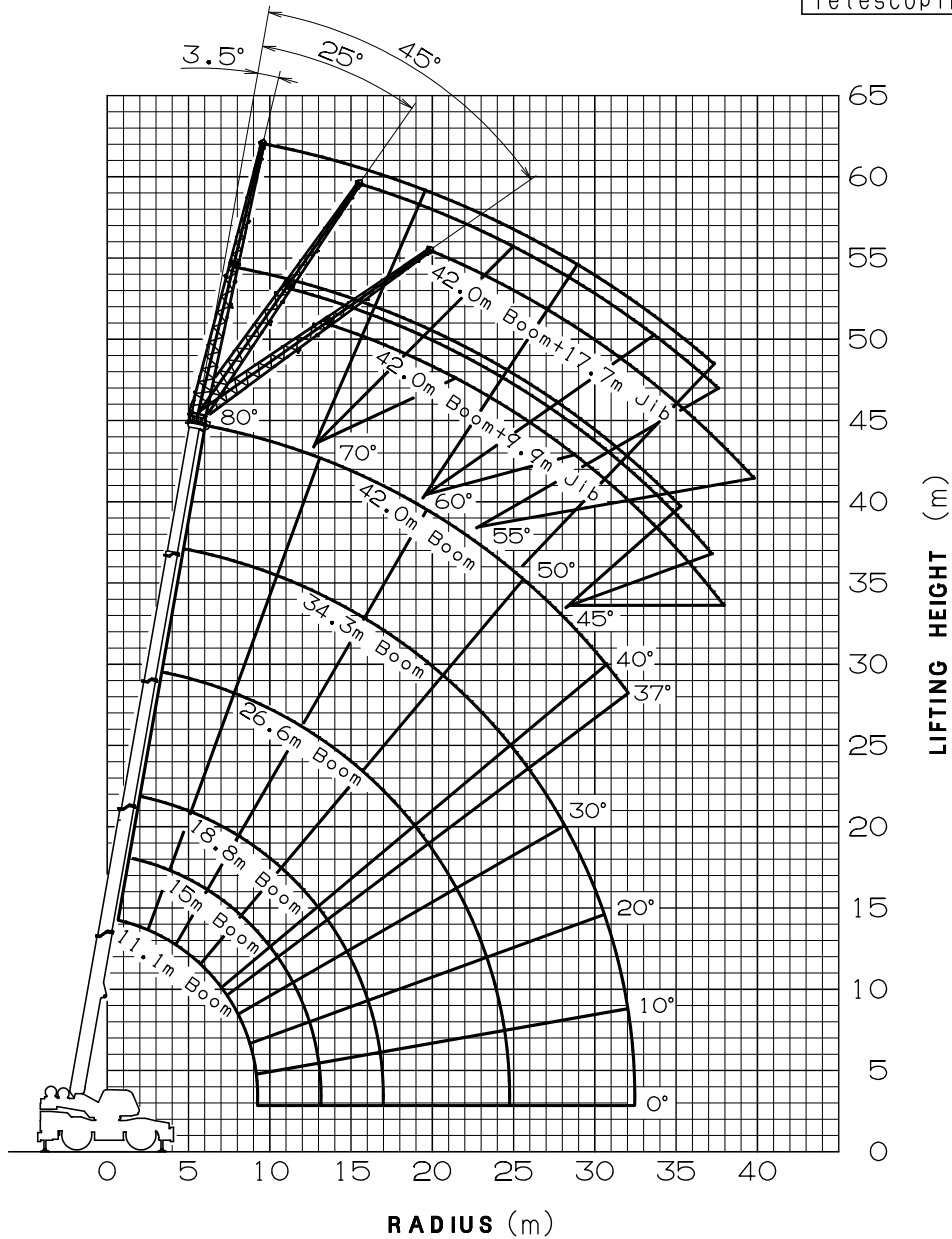

Boom Length

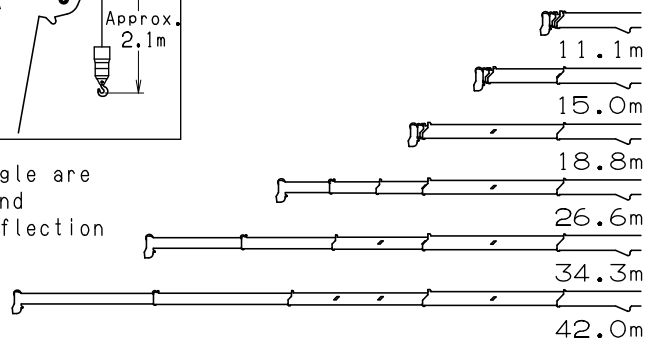

NOTE: 1. The above lifting height and boom angle are based on a straight (unladen) boom, and allowance should be made for boom deflection obtained under laden conditions. The above working range is shown on condition with outriggers fully (7.2m) extended.

WORKING RANGE

Telescoping mode **I**

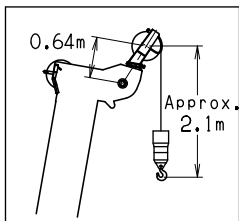
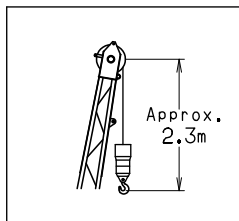
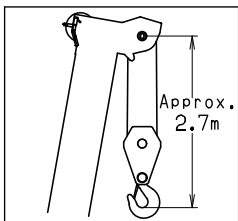
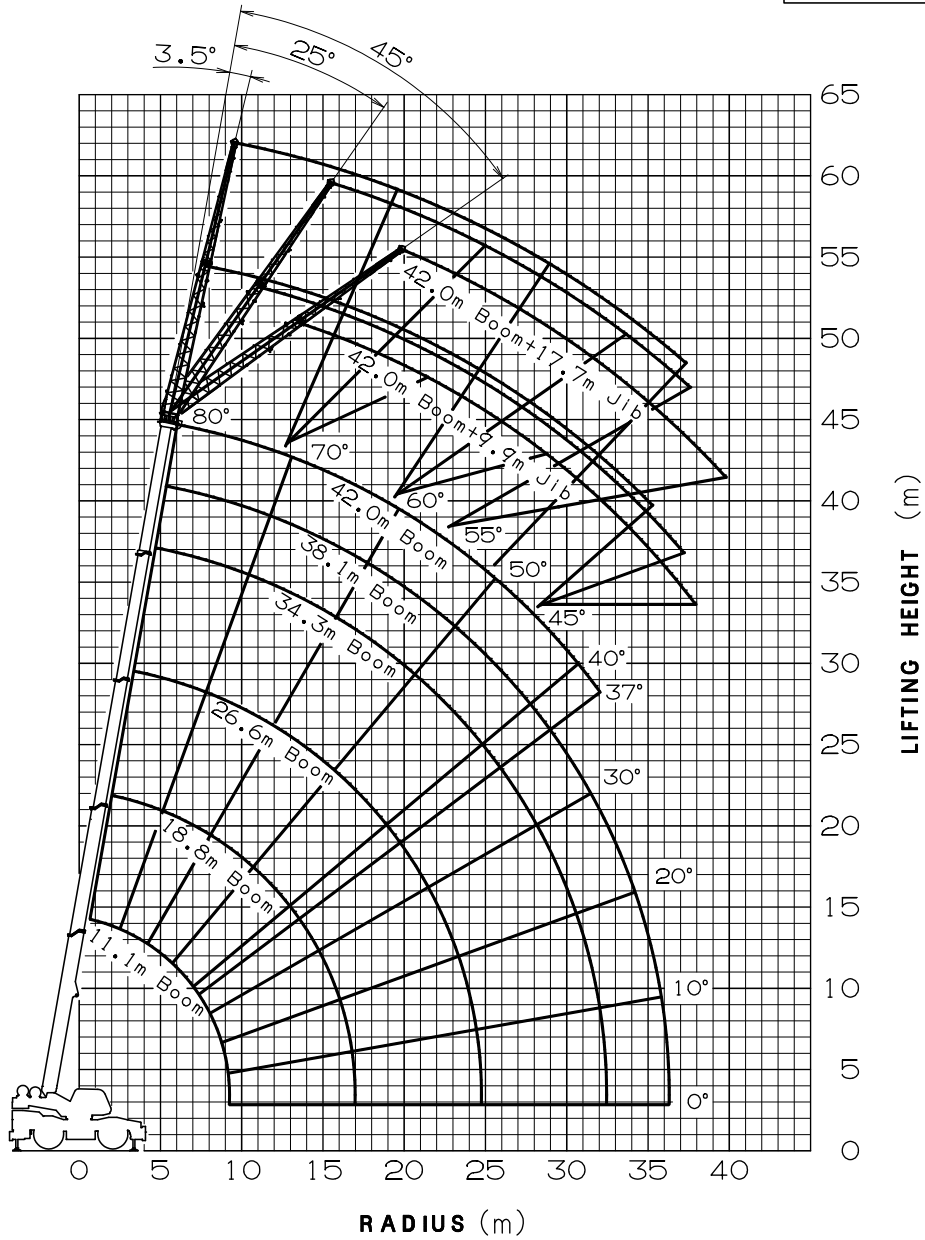

Boom Length

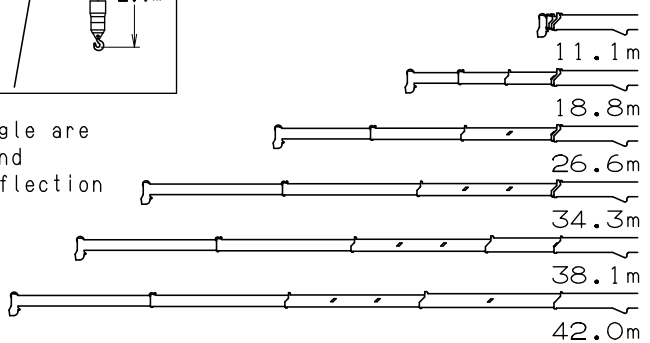

NOTE:1.The above lifting height and boom angle are based on a straight (unladen) boom, and allowance should be made for boom deflection obtained under laden conditions. The above working range is shown on condition with outriggers fully (7.2m) extended.

D I M E N S I O N S

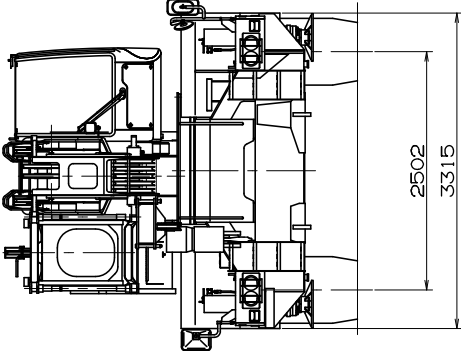
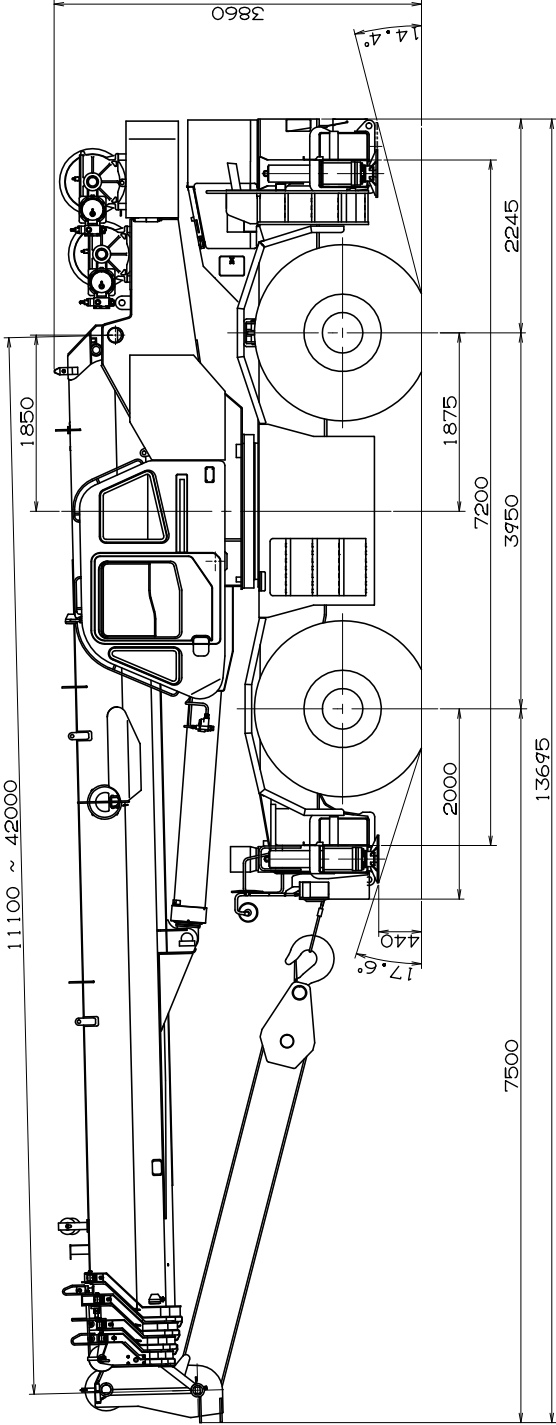
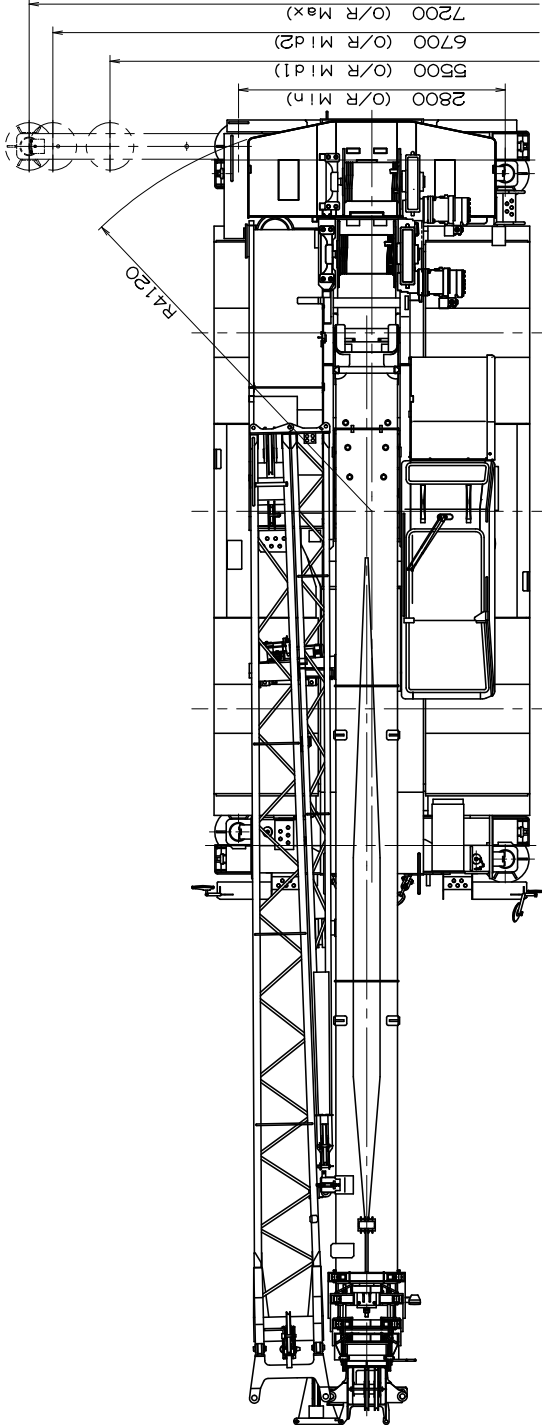

GR-550EX Axle Weight Distribution Chart

UNIT : kg

	GVW	Front	Rear
Basic standard machine includes: 5-section boom (11.1 m - 42.0 m) 2-stage jib (9.9 m, 17.7 m) Mitsubishi 6M60-TLU3B Single top 5.6 ton hook ball Hot water cab heater, air conditioner and defroster Outrigger control box (Both sides of carrier) Emergency steering	43,220	23,125	20,095
Add: 1. 55 ton 6 sheaves hook block 2. 40 ton 4 sheaves hook block 3. 20 ton 2 sheaves hook block	+570 +470 +400	+1,030 +850 +720	-460 -380 -320
Remove: 1. 5.6 ton hook ball 2. Top jib (7.8 m) 3. Base jib (9.9 m)	-150 -307 -831	-209 -367 -1,538	59 60 707