



GT-800XL-2

(Left-hand drive)

80 Ton (72.6 Metric Ton) Capacity

Form NO. GT-800-2-00101/US-01

HYDRAULIC TRUCK CRANE

DIMENSIONS

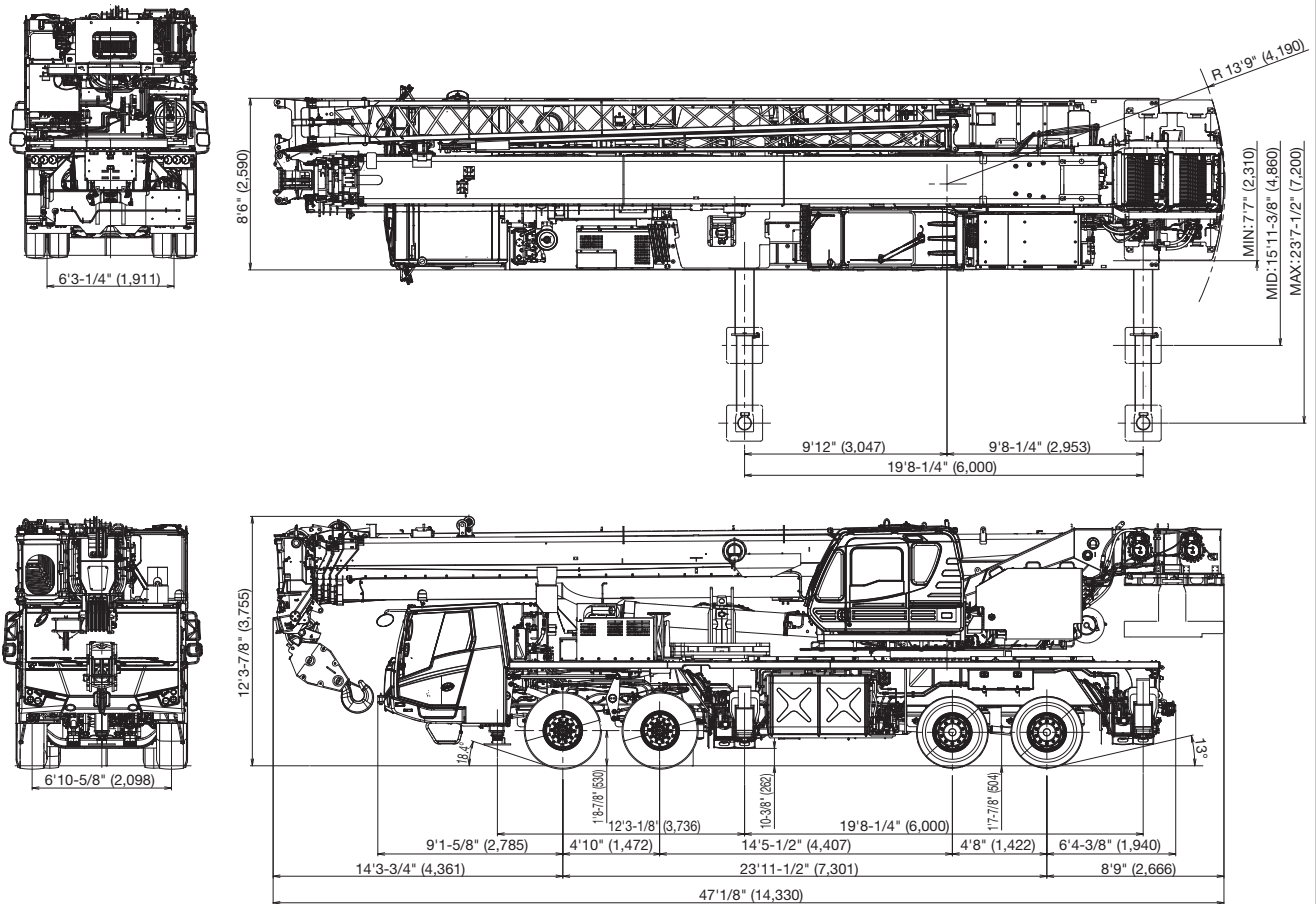

Note: Dimension is with boom angle at -0.4 degree.
() Reference dimensions in mm.

GENERAL DIMENSIONS

	Feet	Meters
Turning radius Front tire (curb to curb)	46' 3"	14.1

TRAVELING

Max. traveling speed 65 mph (105 km/h)

CRANE SPECIFICATIONS

BOOM

5 section full power synchronized telescoping boom, 39.5'-154.3' (12.0 m - 47.0 m), of round box construction with 5 sheaves, 17-5/16" (0.44 m) root diameter, at boom head. The synchronization system consists of 2 telescope cylinders, an extension cable and retraction cable. Hydraulic cylinder fitted with holding valve. 2 easily removable wire rope guards, rope dead end provided on both sides of boom head. Boom telescope sections are supported by wear pads both vertically and horizontally. Extension speed 114.8 ft in 142 seconds.

BOOM ELEVATION - By a double acting hydraulic cylinder with holding valve. Elevation -1.5°-80.5°, combination controls for hand or foot operation. Boom angle indicator. Automatic speed reduction and slow stop function. Boom raising speed 20° to 60° in 46 seconds.

JIB - 2 stage bi-fold lattice type, 3.5°, 25° or 45° offset (tilt type). Single sheave, 15-5/8" (0.396 m) root diameter, at the head of both jib sections. Stored alongside base boom section. Jib length is 33.8' (10.3 m) or 58.7' (17.9 m). Assistant cylinders for mounting and stowing, controlled at right side of superstructure. Self stowing jib mounting pins.

AUXILIARY LIFTING SHEAVE (SINGLE TOP)
Single sheave, 15-5/8" (0.396 m) root diameter. Mounted to main boom head for single line work (stowable).

ANTI-TWO BLOCK - Pendant type over-winding cut out device with audio-visual (FAILURE lamp/BUZZER) warning system.

SLEWING

Hydraulic axial piston motor through planetary slewing speed reducer. Continuous 360° full circle slewing on ball bearing turn table at 1.5 min⁻¹ {rpm}. Equipped with manually locked/released slewing brake. A 360° positive slewing lock for travel modes, manually engaged in cab. Twin slewing system: Free slewing or lock slewing controlled by selector switch on front console.

WINCH

MAIN WINCH - Variable speed type with grooved drum driven by hydraulic axial piston motor through speed reducer. Power load lowering and raising. Equipped with automatic brake (neutral brake) and counterbalance valve. Controlled independently of auxiliary winch. Equipped with cable follower and drum rotation indicator.

DRUM - Grooved 15" (0.382 m) root diameter x 29-1/4" (0.742 m) wide. Wire rope: 892' of 3/4" diameter rope (272 m of 19 mm). Drum capacity: 1293' (394 m) 7 layers. Maximum single line pull: 1st layer 21,800 lbs (9,900 kg). Maximum permissible line pull wire strength: 15,900 lbs (7,200 kg)

AUXILIARY WINCH - Variable speed type with grooved drum driven by hydraulic axial piston motor through speed reducer. Power load lowering and raising. Equipped with automatic brake (neutral brake) and counterbalance valve. Controlled independently of main winch. Equipped with cable follower and drum rotation indicator.

DRUM - Grooved 15" (0.382 m) root diameter x 29-1/4" (0.742 m) wide. Wire rope: 482' of 3/4" diameter rope (147 m of 19 mm). Drum capacity: 1293' (394 m) 7 layers. Maximum single line pull: 1st layer 21,800 lbs (9,900 kg). Maximum permissible line pull wire strength: 15,900 lbs (7,200 kg)

WIRE ROPE - Non-rotating 3/4" (19 mm) 7x35 class. Breaking Strength 79,400 lbs (36,000 kg)

HOOK BLOCKS

100 ton (90.7 metric-ton, option) - 7 sheaves with swivel hook and safety latch.
55 ton (50 metric-ton) - 3 sheaves with swivel hook and safety latch.
22t ton (20 metric ton, option) - 1 sheave with swivel hook block and safety latch.
7.9 ton (7.2 metric ton) - Weighted hook with swivel and safety latch.

COUNTERWEIGHT

Pinned to superstructure frame.

Total mass of counterweights:

- 6,700 lbs
- 12,400 lbs
- 17,900 lbs

Hydraulically controlled counterweight.

HYDRAULIC SYSTEM

PUMPS - 2 variable piston pumps for crane functions. Tandem gear pump for slewing and optional equipment. Powered by carrier engine. Pump disconnect for crane is engaged/ disengaged by rocker switch from carrier cab.

CONTROL VALVES - Multiple valves actuated by pilot pressure with integral pressure relief valves.

RESERVOIR - 160 gallon (600 lit.) capacity. External sight level gauge.

FILTRATION - BETA10=10 return filter, full flow with bypass protection, located inside of hydraulic reservoir. Accessible for easy replacement.

OIL COOLER - Air cooled fan type.

CAB AND CONTROLS

Crane operation can be performed from upper cab mounted on rotating superstructure.

15° tilt, Left side, 1 man type, steel construction with sliding door access and safety glass windows opening at side. Door window is powered control. Windshield glass window and roof glass window are shatter-resistant. Adjustable control lever stands for slewing, boom elevating, boom telescoping, auxiliary winch and main winch. Control lever stands can change neutral positions and tilt for easy access to cab. 3 way adjustable operator's seat with high back, headrest and armrest. Engine throttle knob. Foot operated controls: boom elevating, boom telescoping and engine throttle. Hot water cab heater and air conditioning.

Dash-mounted Instrument panel, Multi Function Display, Starter switch (engine start/stop), 12 V power outlet, USB port, power window switch, slewing brake switch, telescoping/auxiliary winch select switch, free slewing/lock slewing selector switch, air conditioning control switch.

Tadano electronic LOAD MOMENT INDICATOR system (AML-E2) including:

- Control lever lockout function with audible and visual pre-warning
- Number of parts of line
- Boom position indicator
- Outrigger state indicator
- Slewing angle
- Boom angle / boom length / jib offset angle / jib length / load radius / rated lifting capacities / actual loads read out
- Potential lifting height
- Ratio of actual load moment to rated load moment indication
- Automatic Speed reduction and slow stop function on boom elevation and slewing
- Working condition register switch
- Load radius / boom angle / tip height / slewing range preset function
- External warning lamp
- Tare function
- Main Hydraulic oil pressure
- Fuel consumption monitor

- Main winch / auxiliary winch select
- Drum rotation indicator (audible and visible type) main and auxiliary winch

AML-E2 monitors outrigger extended length and automatically programs the corresponding "RATED LIFTING CAPACITIES" table.

Operator's right hand console includes transmission gear selector, slewing lock lever and sight level bubble.

Upper console includes, roof washer and wiper switch, emergency outrigger set up key switch, jib equipped / removed select switch, high speed winch (main / aux) switch, Cab tilt switch, Pump disconnect enable switch and boom emergency.

NOTE: Each crane motion speed is based on unladen conditions.

CARRIER SPECIFICATIONS

TYPE - Left-hand steering, 8 x 4.

FRAME - High tensile steel, all welded mono-box construction.

TRANSMISSION

ZF TraXon 12TX 2615 SO

Automated Manual Transmission, electro-pneumatically operated dry-type clutch and automatic gear shifting with 12 forward gears and 2 reverse gears.

TRANSFER CASE - Two stage.

TRAVEL SPEED - 65 mph (105 km/h)

AXLE

Front: Full floating type, steering axle.
Rear: Full floating type, driving axle.

STEERING - BOSCH-Servocom, dual circuit hydraulic and mechanical steering of both front axles. Transfer-mounted emergency steering pump.

SUSPENSION - Front : Independent air suspension

Rear : Independent air suspension

BRAKE SYSTEMS - Service: ABS system. Full air brakes on all wheels. Dual air line system. Parking / Emergency : Spring loaded brake on rear 4-wheel controlled by knob of spring brake valve. Auxiliary: Constant throttle system with exhaust flap brake.

ENGINE

Model	Cummins X12 (EPA 2021)
Type	Direct injection diesel
No. of cylinders	6
Combustion	4 cycle, turbo charged and after cooled
BoreXStroke, in. (mm)	5.2 x 5.67 (132 x 144)
Displacement, cu. in (liters)	720 (11.8)
Air cleaner	Dry type, replaceable element
Oil filter	Full flow with replaceable element
Fuel filter	Full flow with replaceable element
Fuel tank, gal. (liters)	100 (378), right side of carrier
Cooling	Liquid pressurized, recirculating by-pass

TIRES - Front: 445/65R22.5 Single x4 Rear: 315/80R22.5 Dual x4

OUTRIGGERS- Four hydraulic, beam and jack outriggers.

Hydraulically operated H-type outriggers.

Vertical jack cylinders equipped with integral holding valve.

Each outrigger beam and jack is controlled independently.

Outrigger jack floats are attached thus eliminating the need of manually attaching and detaching them. Controls and sight level bubble located either side of carrier. 4 outrigger extension lengths are provided with corresponding "RATED LIFTING CAPACITIES" for crane duty in confined areas.

Min. extension 7' 7" (2.31 m) center to center

Mid. extension 15' 11 3/8" (4.86 m) center to center

Max. extension 23' 7-1/2" (7.20m) center to center

Float size 21 3/8" x 21 3/8" (0.54 m x 0.54 m)

FRONT JACK - A fifth hydraulically operated outrigger jack.

Mounted to the front frame of carrier. Hydraulic cylinder equipped with integral holding valve and steel float.

CARRIER CAB

Two man full width cab of composite (steel sheet metal and fiber-glass) structure, with safety glass, air-cushioned seats, driver's seat offering various adjustment options, with memory function, engine dependent water heater, air conditioning, multifunction display and Cruise Control.

Radiator	Fin and tube core, thermostat controlled
Fan, in. (mm)	Suction type, 11-blade, (812)
Starting	24 volt
Charging	24 volt system, negative ground
Battery	2-120 amp. Hour
Compressor, air, CFM (l/min)	25.9 (731) @2,000 rpm
Horsepower (kW)	Gross 500 (373)
Torque, Max. ft-lb (Nm)	1700 (2,305)
Capacity, gal. (liters)	
Cooling water	5.5 (21)
Lubrication	11 (42)
Fuel	100 (378)
DEF/AdBlue	15 (57)

STANDARD EQUIPMENT

FOR SUPERSTRUCTURE

- 5 section full power synchronized telescoping boom, 39.5'-154.3' (12.0 m-47.0 m)
- 33.8' or 58.7' (10.3 m or 17.9 m) quick reeving type bi-fold lattice jib (tilt type) with 3.5°, 25° or 45° pinned offsets and self storing pins.
- Auxiliary lifting sheave (single top) stowable
- 55 ton (50 metric ton) - 3 sheaves with swivel hook block and safety latch for 3/4" (19 mm) wire rope
- 7.9 ton (7.2 metric ton) hook ball with swivel
- Variable speed main hoist with grooved drum, cable follower and 892' of 3/4" cable.
- Variable speed auxiliary hoist with grooved drum, cable follower and 482' of 3/4" cable.
- 2-speed winch
- Tadano electronic load moment indicator system (AML-E2)
- Self-removable counterweight (total 17,900 lbs)
- Independently controlled outriggers
- Three outrigger extension positions (min/mid/max)
- Outrigger extension length detectors
- Front jack (Fifth jack)
- Trailer coupling device
- Hydraulic circuit for dolly (Elevation, swing and swing brake)
- Smart Chart
- Drum rotation indicator (audible, visible and thumper type) main and auxiliary hoist
- Anti-Two block device (overwind cutout)
- Winch over-unwinding prevention
- Telematics (machine data logging and monitoring system) with HELLO-NET via internet
- Hydraulic oil cooler
- Weighted hook storage compartment
- Tadano twin slewing system and 360° positive slewing lock
- LED work lights
- Positive control
- Eco mode system
- Winch drum cameras
- Boom angle indicator
- 15° tilt cab
- Self centering finger control levers with pilot control
- Control pedals for boom elevating and boom telescoping
- 3 way adjustable cloth seat with armrests and high back
- Hot water cab heater and air conditioner
- Tinted safety glass and sun visor

- Front windshield wiper and washer
- Roof window wiper and washer
- Power window (cab door)
- 12 V power outlet
- USB port (power supply)
- Annemometer

FOR CARRIER

- Cummins X12 (EPA 2021) direct injection diesel engine
- ZF TraXon 12TX 2615 SO automatic mechanical transmission with electro-pneumatically operated dry-type clutch and automatic gear shifting with 12 forward gears and 2 reverse gears.
- ZF TC27L Transfer case (2 stage)
- Hendrickson independent air suspensions
- 8 x 4 Drive
- Inter wheel differential lock on axles 3 and 4
- Aluminum disc wheels
- Front tires 445/65R22.5 Single x4
- Rear tiers 315/80R22.5 Dual x4
- Air Disc brakes
- Anti-lock braking system (ABS)
- Engine compression brake
- BOSCH-Servocom, dual circuit hydraulic and mechanical steering system with emergency steering pump Multi Function Display
- Fuel Tank 100 gallon
- Adblue Tank 15 gallon
- Hook block tie down (front bumper)
- Towing hooks-Front and rear
- Carrier mounted storage box
- Aluminum fenders
- Air dryer
- Water separator with filter(high filtration)
- Battery Disconnect Switch
- Backup camera
- Beacon lamp
- Resin full cab
- 3 way adjustable air-cushioned seat
- Tilt telescoping steering wheel
- Hourmeter (Operation from the carrier and superstructure)
- Air conditioning
- USB port (power supply)
- Cruise control
- Clearance sonar (Rear side)

OPTIONAL EQUIPMENT

FOR SUPERSTRUCTURE

- 100 ton (90.7 metric ton) - 7 sheaves with swivel hook block and safety latch for 3/4" (19 mm) wire rope
- 22t ton (20 metric ton) - 1 sheave with swivel hook block and safety latch for 3/4" (19 mm) wire rope
- Tire inflation kit

HOISTING PERFORMANCE

LINE SPEEDS AND PULLS

Layer	Main or auxiliary winch - 15" (0.382 m) drum					
	Line speeds ¹				Line pulls Available ²	
	Low		High		Low	
	F.P.M	m/min	F.P.M	m/min	Lbs.	kgf
1st	253	77	354	108	21,800	9,900
2nd	276	84	384	117	19,900	9,010
3rd	299	91	413	126	18,200	8,270
4th	318	97	446	136	16,800	7,640
5th	341	104	476	145	15,600	7,090

- Maximum permissible line pull wire strength. 15,900 lbs (7,200 kg) with 7 x 35 class rope.

¹ Line speeds based only on hook block, not loaded.

² Developed by machinery with each layer of wire rope, but not based on rope strength or other limitation in machinery or equipment.

DRUM WIRE ROPE CAPACITIES

Wire rope layer	Main and auxiliary drum grooved lagging			
	3/4" (19 mm) wire rope			
	Rope per layer		Total wire rope	
	Feet	Meter	Feet	Meter
1	147.0	44.8	147.0	44.8
2	159.4	48.6	306.4	93.4
3	172.2	52.5	478.7	145.9
4	184.7	56.3	663.4	202.2
5	197.2	60.1	860.6	262.3

DRUM DIMENSIONS

	Inch	mm
Root diameter	15"	382
Length	29-1/4"	742
Flange diameter	26-5/8"	677

GT-800XL-2 WORKING RANGE CHART

360° ROTATION

Unit: klbs

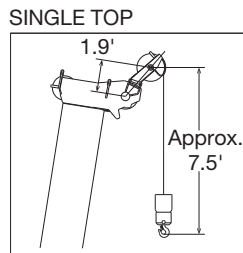
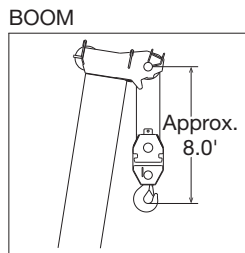
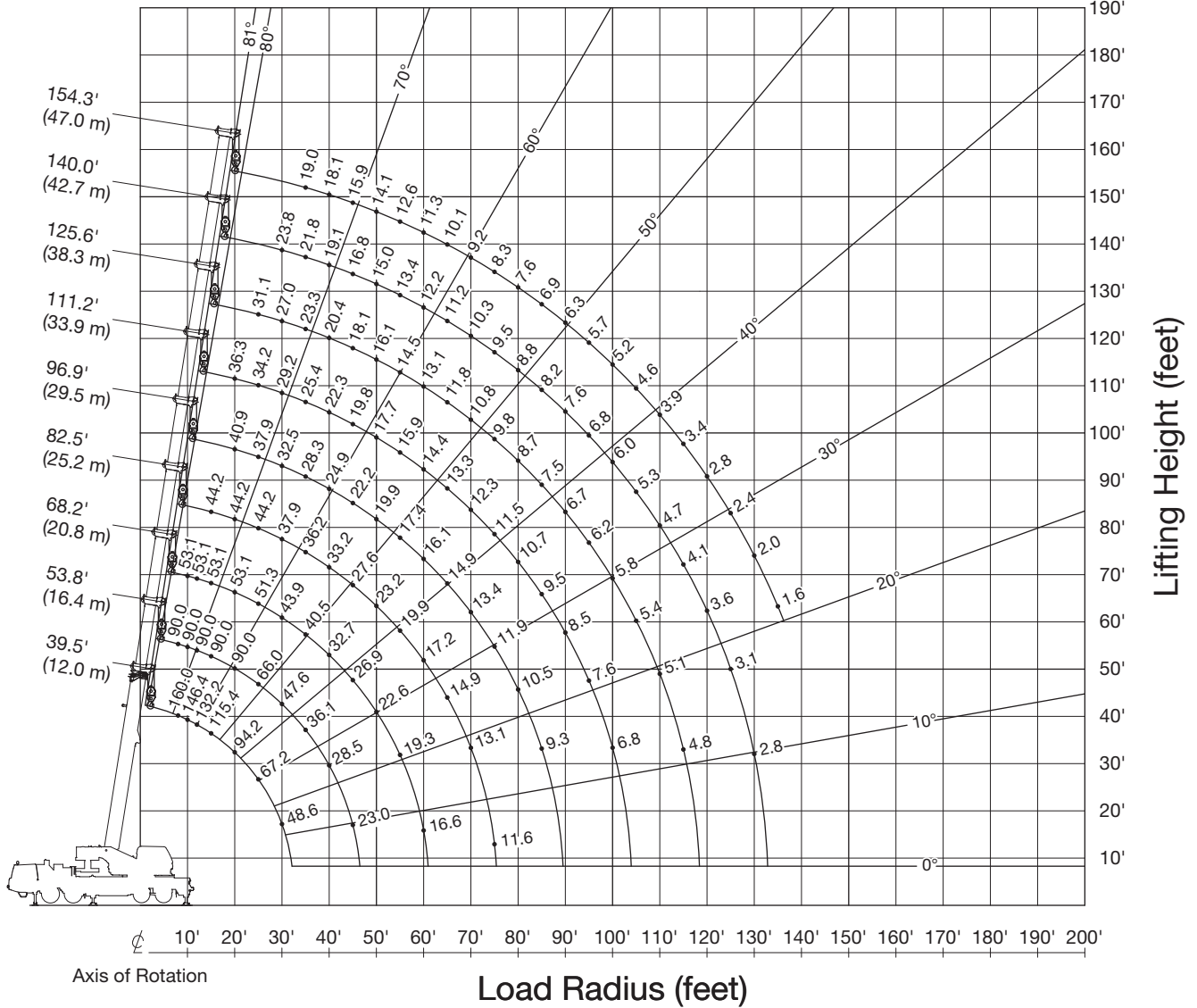

NOTE: Boom geometry shown are for unloaded condition and machine standing level on firm supporting surface. Boom deflection and subsequent radius and boom angle change must be accounted for when applying load to hook.

GT-800XL-2 WORKING RANGE CHART

SMART CHART

Unit: klbs

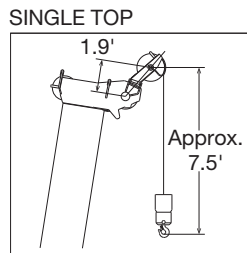
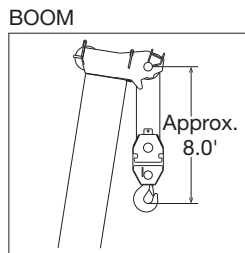
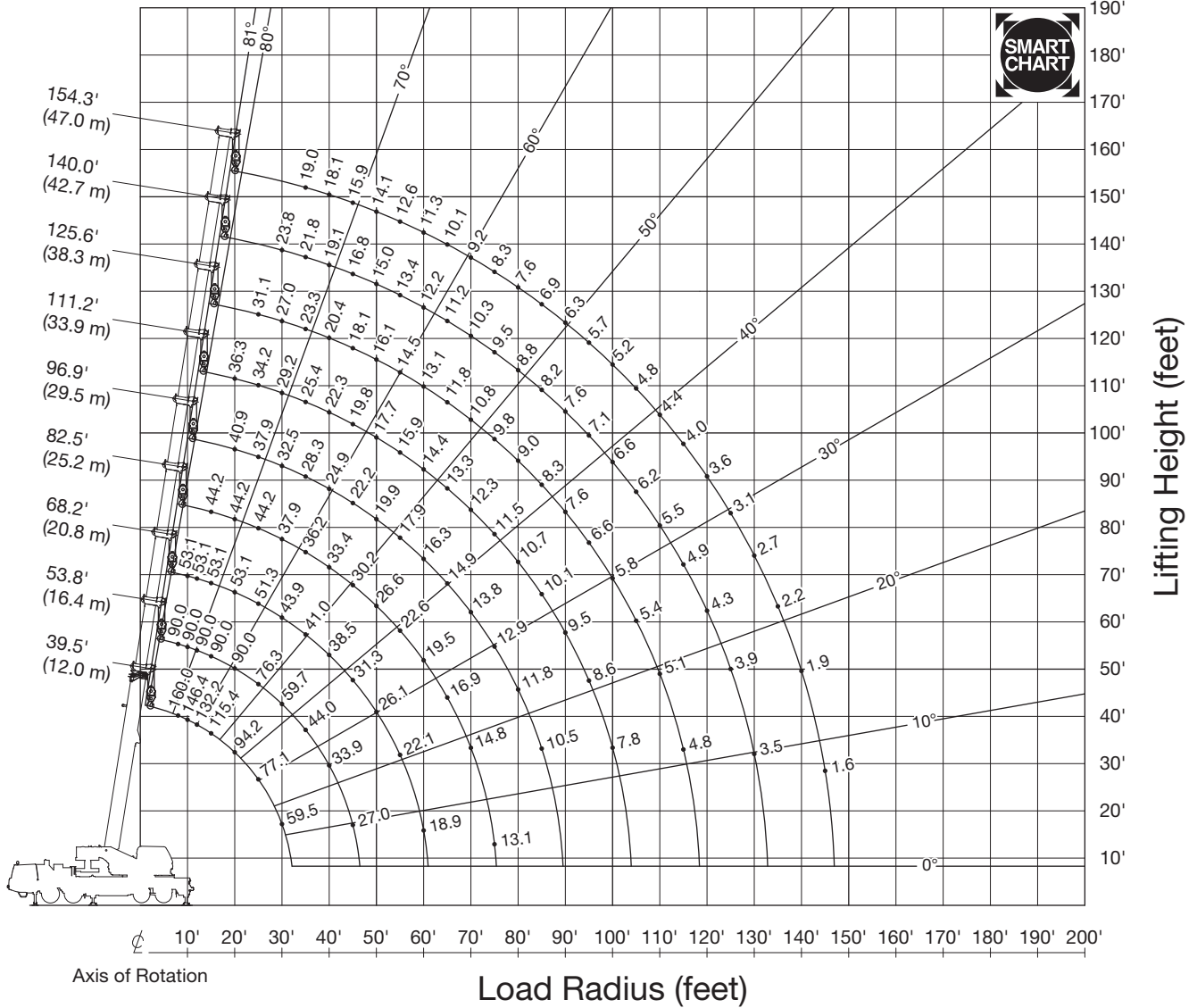
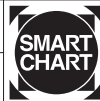

NOTE: Boom geometry shown are for unloaded condition and machine standing level on firm supporting surface. Boom deflection and subsequent radius and boom angle change must be accounted for when applying load to hook.

GT-800XL-2 WORKING RANGE CHART

360° ROTATION

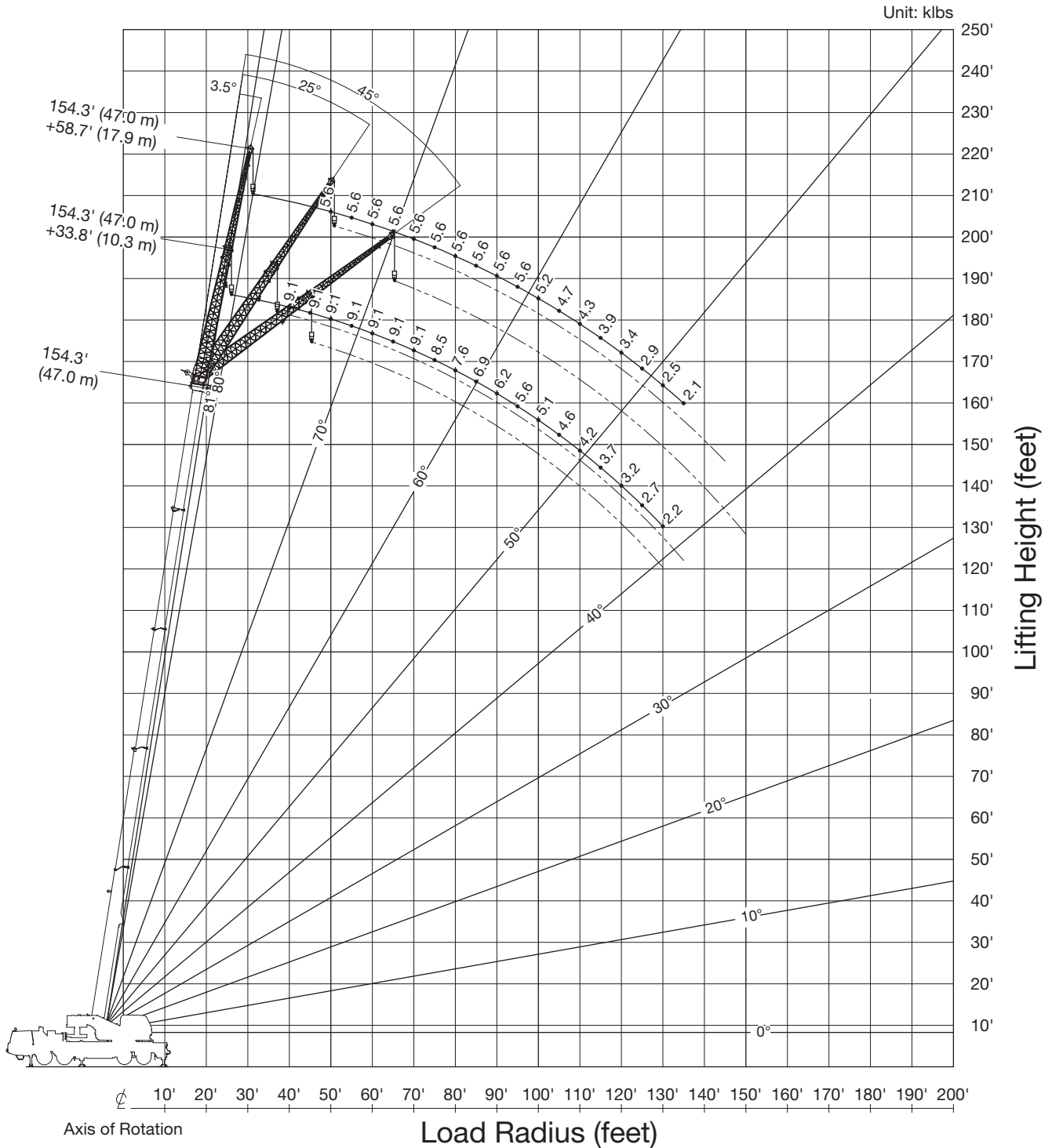

NOTE: Jib geometry shown are for unloaded condition and machine standing level on firm supporting surface. Boom deflection and subsequent radius and boom angle change must be accounted for when applying load to hook.

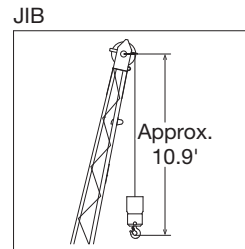

GT-800XL-2 WORKING RANGE CHART

SMART CHART

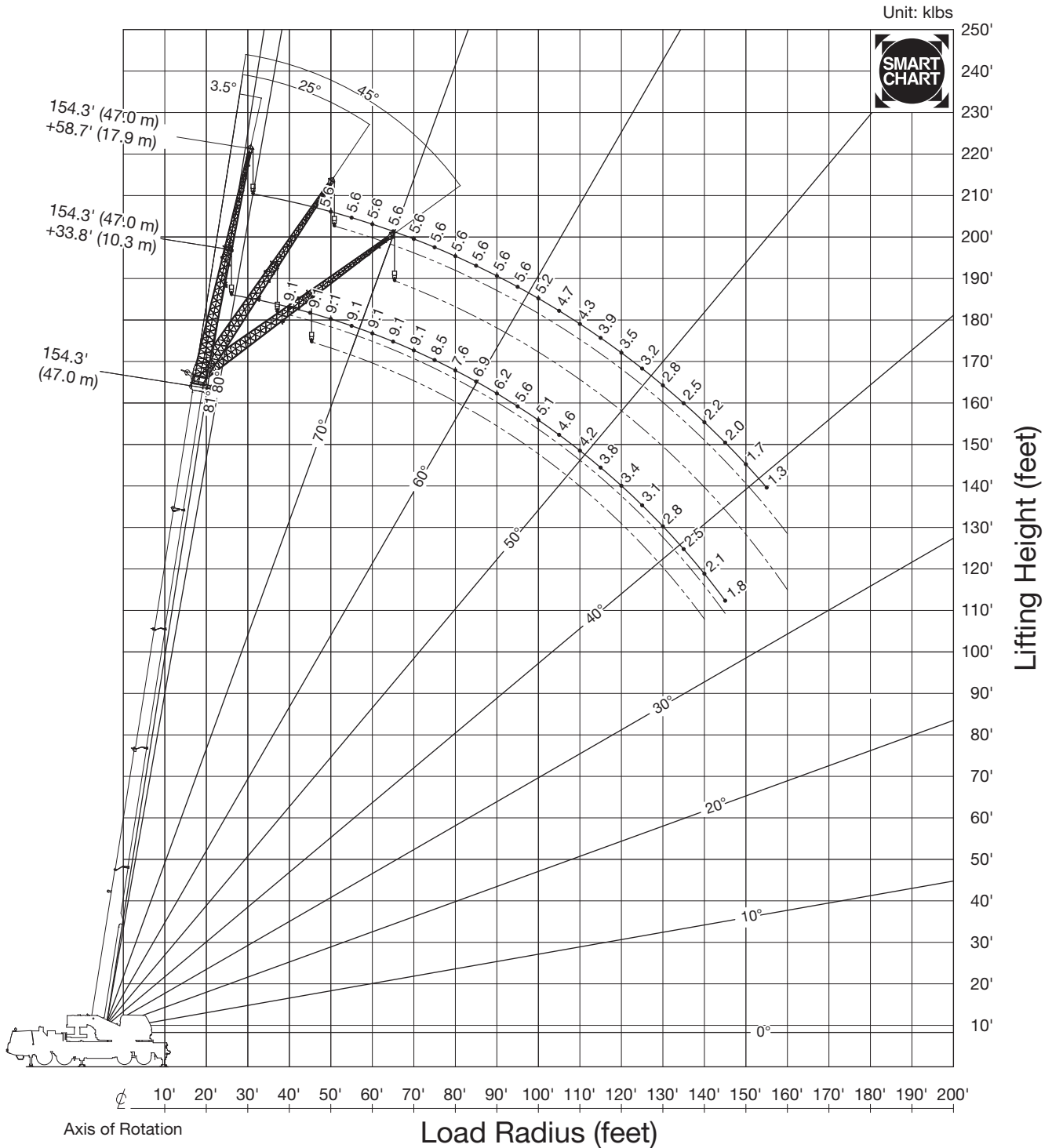

NOTE: Jib geometry shown are for unloaded condition and machine standing level on firm supporting surface. Boom deflection and subsequent radius and boom angle change must be accounted for when applying load to hook.

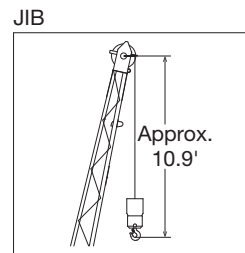

GT-800XL-2 RATED LIFTING CAPACITIES (IN POUNDS)

COUNTERWEIGHT 17,900 lbs (8.1 t) ON OUTRIGGER FULLY EXTEND 23'7-1/2" (7.2 m) SPREAD 360° ROTATION															
Load Radius in Feet	Boom Length														
	39.5' (12.0 m)	53.8' (16.4 m)	68.2' (20.8 m)		82.5' (25.2 m)		96.9' (29.5 m)		111.2' (33.9 m)		125.6' (38.3 m)		140.0' (42.7 m)		154.3' (47.0 m)
8'	160,000	90,000													
10'	146,400	90,000	53,100	41,000											
12'	132,200	90,000	53,100	41,000											
15'	115,400	90,000	53,100	41,000	44,200	36,200									
20'	94,200	90,000	53,100	41,000	44,200	36,200	40,900	34,300	36,300	33,300					
25'	67,200	66,000	51,300	41,000	44,200	36,200	37,900	33,700	34,200	30,500	31,100	26,100			
30'	48,600	47,600	43,900	41,000	37,900	36,200	32,500	29,400	29,200	26,600	27,000	22,300	23,800	22,300	
35'		36,100	35,700	40,500	32,900	36,200	28,300	25,900	25,400	23,400	23,300	19,400	21,800	20,800	19,000
40'		28,500	28,100	32,700	28,900	33,200	24,900	23,200	22,300	20,900	20,400	17,100	19,100	18,400	18,100
45'		23,000	22,500	26,900	23,900	27,600	22,200	20,900	19,800	18,800	18,100	15,200	16,800	16,400	15,900
50'			18,300	22,600	19,700	23,200	19,900	19,000	17,700	17,100	16,100	13,600	15,000	14,800	14,100
55'			15,100	19,300	16,400	19,900	17,300	17,400	15,900	15,600	14,500	12,300	13,400	13,400	12,600
60'			12,500	16,600	13,800	17,200	14,600	16,100	14,400	14,400	13,100	11,100	12,100	12,200	11,300
65'					11,600	14,900	12,500	14,900	13,100	13,300	11,800	10,100	10,900	11,200	10,100
70'					9,700	13,100	10,600	13,400	11,200	12,300	10,800	9,300	9,900	10,300	9,200
75'					8,200	11,600	9,000	11,900	9,600	11,500	9,800	8,500	9,000	9,500	8,300
80'							7,700	10,500	8,300	10,700	8,700	7,800	8,200	8,800	7,600
85'							6,500	9,300	7,100	9,500	7,500	7,200	7,500	8,200	6,900
90'									6,100	8,500	6,500	6,700	6,700	7,600	6,300
95'									5,200	7,600	5,600	6,200	5,900	6,800	5,700
100'									4,400	6,800	4,800	5,800	5,100	6,000	5,200
105'											4,100	5,400	4,400	5,300	4,600
110'											3,500	5,100	3,700	4,700	3,900
115'											3,000	4,800	3,200	4,100	3,400
120'													2,700	3,600	2,800
125'													2,200	3,100	2,400
130'													1,900	2,800	2,000
135'															1,600
140'															
145'															
A													11°	0°	26°
Telescoping conditions (%)															
Telescoping mode	1, 2	1	1	2	1	2	1	2	1	2	1	2	1	2	1, 2
2nd Boom	0	50	100	0	100	0	100	0	100	0	100	0	100	50	100
3rd Boom	0	0	0	33	16	50	33	67	50	83	67	100	83	100	100
4th Boom	0	0	0	33	16	50	33	67	50	83	67	100	83	100	100
Top Boom	0	0	0	33	16	50	33	67	50	83	67	100	83	100	100

A : Minimum boom angle (°) for indicator length (no load)

GT-800XL-2 RATED LIFTING CAPACITIES (IN POUNDS)

COUNTERWEIGHT 17,900 lbs (8.1 t) ON OUTRIGGER FULLY EXTEND 23'7-1/2" (7.2 m) SPREAD SMART CHART															
Load Radius in Feet	Boom Length														
	39.5' (12.0 m)	53.8' (16.4 m)	68.2' (20.8 m)		82.5' (25.2 m)		96.9' (29.5 m)		111.2' (33.9 m)		125.6' (38.3 m)		140.0' (42.7 m)		154.3' (47.0 m)
8'	160,000	90,000													
10'	146,400	90,000	53,100	41,000											
12'	132,200	90,000	53,100	41,000											
15'	115,400	90,000	53,100	41,000	44,200	36,200									
20'	94,200	90,000	53,100	41,000	44,200	36,200	40,900	34,300	36,300	33,300					
25'	77,100	76,300	51,300	41,000	44,200	36,200	37,900	33,700	34,200	30,500	31,100	26,100			
30'	69,500	59,700	43,900	41,000	37,900	36,200	32,500	29,400	29,200	26,600	27,000	22,300	23,800	22,300	
35'		44,000	38,100	41,000	32,900	36,200	28,300	25,900	25,400	23,400	23,300	19,400	21,800	20,800	19,000
40'		33,900	33,300	38,500	28,900	33,400	24,900	23,200	22,300	20,900	20,400	17,100	19,100	18,400	18,100
45'		27,000	26,500	31,300	25,600	30,200	22,200	20,900	19,800	18,800	18,100	15,200	16,800	16,400	15,900
50'			21,400	26,100	22,800	26,600	19,900	19,000	17,700	17,100	16,100	13,600	15,000	14,800	14,100
55'			17,500	22,100	18,900	22,600	17,900	17,400	15,900	15,600	14,500	12,300	13,400	13,400	12,600
60'			14,400	18,900	15,900	19,500	16,300	16,100	14,400	14,400	13,100	11,100	12,100	12,200	11,300
65'					13,400	16,900	14,200	14,900	13,100	13,300	11,800	10,100	10,900	11,200	10,100
70'					11,300	14,800	12,200	13,800	12,000	12,300	10,800	9,300	9,900	10,300	9,200
75'					9,600	13,100	10,400	12,900	11,000	11,500	9,800	8,500	9,000	9,500	8,300
80'							9,000	11,800	9,600	10,700	9,000	7,800	8,200	8,800	7,600
85'							7,700	10,500	8,300	10,100	8,300	7,200	7,500	8,200	6,900
90'									7,200	9,500	7,600	6,700	6,900	7,600	6,300
95'									6,200	8,600	6,600	6,200	6,300	7,100	5,700
100'									5,400	7,800	5,700	5,800	5,800	6,600	5,200
105'											5,000	5,400	5,300	6,200	4,800
110'											4,300	5,100	4,600	5,500	4,400
115'											3,700	4,800	4,000	4,900	4,000
120'													3,400	4,300	3,600
125'													3,000	3,900	3,100
130'													2,500	3,500	2,700
135'															2,200
140'															1,900
145'															1,600
A															0°
Telescoping conditions (%)															
Telescoping mode	1, 2	1	1	2	1	2	1	2	1	2	1	2	1	2	1, 2
2nd Boom	0	50	100	0	100	0	100	0	100	0	100	0	100	50	100
3rd Boom	0	0	0	33	16	50	33	67	50	83	67	100	83	100	100
4th Boom	0	0	0	33	16	50	33	67	50	83	67	100	83	100	100
Top Boom	0	0	0	33	16	50	33	67	50	83	67	100	83	100	100

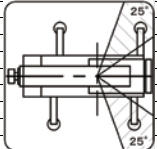

A : Minimum boom angle (°) for indicator length (no load)

GT-800XL-2 RATED LIFTING CAPACITIES (IN POUNDS)

COUNTERWEIGHT 17,900 lbs (8.1 t) ON OUTRIGGER FULLY EXTEND 23'7-1/2" (7.2 m) SPREAD 360° ROTATION 33.8' (10.3 m) Jib																					
Load Radius in Feet	Boom Length, Jib Offset Angle (°)																				
	111.2' (33.9 m) Boom						125.6' (38.3 m) Boom						140.0' (42.7 m) Boom						154.3' (47.0 m) Boom		
	3.5°		25°		45°		3.5°		25°		45°		3.5°		25°		45°		3.5°	25°	45°
30'	14,600	11,500																			
35'	14,600	11,500					13,200	11,300													
40'	14,600	11,500	12,600	10,900			13,200	11,300												9,100	
45'	14,600	11,500	12,000	10,900			13,200	11,300												9,100	
50'	14,600	11,500	11,400	10,900	9,100	9,000	13,200	11,300	11,200	10,800											
55'	14,600	11,500	10,900	10,600	8,900	8,700	13,200	11,300	10,800	10,400											
60'	13,500	11,500	10,500	10,200	8,600	8,500	12,700	10,400	10,400	10,100	8,600	8,400									
65'	12,300	11,500	10,100	9,800	8,400	8,300	11,400	9,400	10,000	9,300	8,400	8,200									
70'	11,200	10,900	9,700	9,400	8,200	8,100	10,400	8,600	9,700	8,600	8,200	8,000									
75'	10,200	10,100	9,400	9,100	8,000	7,900	9,400	7,800	9,300	7,800	8,000	7,800									
80'	9,300	9,400	9,100	8,800	7,900	7,700	8,600	7,100	8,700	7,200	7,800	7,200									
85'	8,600	8,800	8,600	8,600	7,700	7,600	7,800	6,500	8,000	6,600	7,700	6,700									
90'	7,500	8,200	8,000	8,100	7,600	7,500	7,200	6,000	7,300	6,100	7,500	6,100									
95'	6,600	7,700	7,300	7,700	7,400	7,400	6,600	5,500	6,700	5,600	6,800	5,600									
100'	5,800	7,300	6,300	7,200	6,700	7,200	5,800	5,000	6,200	5,200	6,300	5,200									
105'	5,000	6,800	5,500	6,800	5,800	6,800	5,100	4,700	5,700	4,800	5,800	4,800									
110'	4,300	6,100	4,800	6,400			4,400	4,300	5,000	4,400	5,200	4,400									
115'	3,700	5,500	4,100	5,800			3,800	3,900	4,300	4,000	4,500	4,100									
120'	3,200	4,900	3,500	5,200			3,300	3,600	3,700	3,700											
125'	2,700	4,500	3,000	4,600			2,800	3,400	3,200	3,400											
130'	2,300	4,000					2,400	3,100	2,600	3,200											
135'	1,900	3,600					1,900	2,800	2,200	2,900											
140'								2,600	1,700	2,700											
145'								2,400													
150'																					
155'																					
Telescoping conditions																					
Telescoping mode	1	2	1	2	1	2	1	2	1	2	1	2	1	2	1	2	1	2	1,2		

COUNTERWEIGHT 17,900 lbs (8.1 t) ON OUTRIGGER FULLY EXTEND 23'7-1/2" (7.2 m) SPREAD 360° ROTATION 58.7' (17.9 m) Jib																					
Load Radius in Feet	Boom Length, Jib Offset Angle (°)																				
	111.2' (33.9 m) Boom						125.6' (38.3 m) Boom						140.0' (42.7 m) Boom						154.3' (47.0 m) Boom		
	3.5°		25°		45°		3.5°		25°		45°		3.5°		25°		45°		3.5°	25°	45°
35'	7,700	7,000																			
40'	7,700	7,000					6,900	6,300													
45'	7,700	7,000					6,900	6,300													
50'	7,700	7,000					6,900	6,300													
55'	7,700	7,000	6,500	6,300			6,900	6,300													
60'	7,700	7,000	6,500	6,300			6,900	6,300													
65'	7,700	7,000	6,500	6,300			6,900	6,300	6,800	6,300											
70'	7,700	7,000	6,500	6,300	5,300	4,800	6,900	6,300	6,600	6,300											
75'	7,700	7,000	6,400	6,300	5,100	4,800	6,900	6,300	6,400	6,200	5,100	4,800									
80'	7,700	7,000	6,200	6,100	5,000	4,800	6,900	6,300	6,200	6,000	5,000	4,800									
85'	7,700	7,000	5,900	5,800	4,800	4,800	6,900	6,300	6,000	5,800	4,900	4,800									
90'	7,500	7,000	5,700	5,600	4,700	4,700	6,900	5,700	5,800	5,500	4,700	4,700									
95'	7,000	6,900	5,500	5,400	4,600	4,500	6,500	5,300	5,600	5,200	4,600	4,600									
100'	6,500	6,700	5,300	5,200	4,500	4,400	6,000	4,800	5,400	4,900	4,500	4,500									
105'	5,800	6,400	5,100	5,000	4,400	4,300	5,500	4,400	5,200	4,700	4,400	4,300									
110'	5,200	6,100	4,900	4,900	4,300	4,200	5,000	4,100	5,000	4,300	4,300	4,200									
115'	4,500	5,800	4,800	4,700	4,200	4,200	4,500	3,700	4,900	4,000	4,200	4,000									
120'	4,000	5,400	4,700	4,600	4,100	4,100	3,900	3,500	4,500	3,700	4,100	3,800									
125'	3,500	5,000	4,200	4,500	4,100	4,100	3,400	3,200	4,200	3,400	4,100	3,500									
130'	3,000	4,500	3,600	4,300	4,000	4,000	2,900	2,900	3,700	3,100	4,000	3,200									
135'	2,600	4,100	3,200	4,300			2,500	2,700	3,200	2,800	3,500	3,000									
140'	2,200	3,700	2,700	4,000			2,100	2,400	2,800	2,600	3,000	2,700									
145'	1,900	3,300		3,600			1,800	2,200	2,300	2,400	3,000	2,700									
150'	1,500	3,000		3,200			2,100	1,900	2,000	2,200	2,600	2,600									
155'		2,700					1,900		2,000												
160'		2,400					1,700		1,800												
Telescoping conditions																					
Telescoping mode	1	2	1	2	1	2	1	2	1	2	1	2	1	2	1	2	1	2	1,2		

GT-800XL-2 RATED LIFTING CAPACITIES (IN POUNDS)

SMART CHART		COUNTERWEIGHT 17,900 lbs (8.1 t) ON OUTRIGGER FULLY EXTEND 23'7-1/2" (7.2 m) SPREAD SMART CHART 33.8' (10.3 m) Jib																	
		Boom Length, Jib Offset Angle (°)																	
		111.2' (33.9 m) Boom			125.6' (38.3 m) Boom			140.0' (42.7 m) Boom			154.3' (47.0 m) Boom								
Load Radius in Feet	3.5°	25°	45°	3.5°	25°	45°	3.5°	25°	45°	3.5°	25°	45°	3.5°	25°	45°				
30'	14,600	11,500																	
35'	14,600	11,500																	
40'	14,600	11,500	12,600	10,900			13,200	11,300					10,400	10,100					
45'	14,600	11,500	12,000	10,900			13,200	11,300					10,400	10,100				9,100	
50'	14,600	11,500	11,400	10,900	9,100	9,000	13,200	11,300	11,700	10,900			10,400	10,100	10,200	10,100		9,100	
55'	14,600	11,500	10,900	10,600	8,900	8,700	13,200	11,300	10,800	10,400			8,800	8,600	8,800	8,700	8,600	9,100	
60'	13,500	11,500	10,500	10,200	8,600	8,500	12,700	10,400	10,400	10,100			8,600	8,400	8,600	8,400	8,400	9,100	
65'	12,300	11,500	10,100	9,800	8,400	8,300	11,400	9,400	10,000	9,900			8,400	8,200	8,400	8,200	8,200	9,100	
70'	11,200	10,900	9,700	9,400	8,200	8,100	10,400	8,600	9,700	8,600			8,200	8,000	8,200	8,000	8,000	9,100	
75'	10,200	10,100	9,400	9,100	8,000	7,900	9,400	7,800	9,300	7,800			8,000	7,800	8,000	7,800	7,800	8,500	
80'	9,300	9,400	9,100	8,800	7,900	7,700	8,600	7,100	8,700	7,200			7,800	7,200	7,800	7,700	7,600	7,900	
85'	8,600	8,800	8,600	8,600	7,700	7,600	7,800	6,500	8,000	6,600			7,700	6,700	7,300	7,200	7,500	7,300	
90'	7,900	8,200	8,000	8,100	7,600	7,500	7,200	6,000	7,300	6,100			7,500	6,100	6,600	6,700	6,900	6,700	
95'	7,300	7,700	7,300	7,700	7,400	7,400	6,600	5,500	6,700	5,600			6,800	5,600	6,000	6,100	6,300	6,100	
100'	6,700	7,300	6,800	7,200	6,800	7,200	6,000	5,000	6,200	5,200			6,300	5,200	5,500	5,700	5,900	5,600	
105'	5,900	6,900	6,300	6,800	6,300	6,800	5,500	4,700	5,700	4,800			5,800	4,800	5,000	5,300	5,200	5,300	
110'	5,200	6,500	5,700	6,400			5,100	4,300	5,200	4,400			5,300	4,400	4,600	4,900	4,900	4,200	
115'	4,600	6,100	4,900	6,100			4,700	3,900	4,800	4,000			4,900	4,100	4,200	4,500	4,400	3,800	
120'	4,000	5,700	4,300	5,800			4,100	3,600	4,400	3,700			3,800	4,200	4,000	4,200	4,100	3,400	
125'	3,500	5,200	3,700	5,400			3,500	3,400	3,900	3,400			3,500	3,900	3,600	3,900	3,700	3,100	
130'	3,000	4,700					3,000	3,100	3,400	3,200			3,100	3,600	3,300	3,700	3,400	2,800	
135'	2,500	4,300					2,600	2,800	2,800	2,900			2,700	3,400	3,000	3,400		2,500	
140'							2,600	2,400	2,700				2,200	3,000	2,500	3,200		2,100	
145'							2,400						1,900	2,600	2,100	2,800		1,800	
150'							2,200						2,200		2,400				
155'													1,900		2,100				

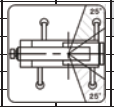

Telescoping conditions

Telescoping mode	1	2	1	2	1	2	1	2	1	2	1	2	1	2	1	2	1	2	1,2
------------------	---	---	---	---	---	---	---	---	---	---	---	---	---	---	---	---	---	---	-----

SMART CHART		COUNTERWEIGHT 17,900 lbs (8.1 t) ON OUTRIGGER FULLY EXTEND 23'7-1/2" (7.2 m) SPREAD SMART CHART 58.7' (17.9 m) Jib																	
		Boom Length, Jib Offset Angle (°)																	
		111.2' (33.9 m) Boom			125.6' (38.3 m) Boom			140.0' (42.7 m) Boom			154.3' (47.0 m) Boom								
Load Radius in Feet	3.5°	25°	45°	3.5°	25°	45°	3.5°	25°	45°	3.5°	25°	45°	3.5°	25°	45°				
35'	7,700	7,000																	
40'	7,700	7,000																	
45'	7,700	7,000																	
50'	7,700	7,000																	
55'	7,700	7,000	6,500	6,300															
60'	7,700	7,000	6,500	6,300															
65'	7,700	7,000	6,500	6,300															
70'	7,700	7,000	6,500	6,300	5,300	4,800	6,900	6,300	6,600	6,300									
75'	7,700	7,000	6,400	6,300	5,100	4,800	6,900	6,300	6,400	6,200									
80'	7,700	7,000	6,200	6,100	5,000	4,800	6,900	6,300	6,200	6,000									
85'	7,700	7,000	5,900	5,800	4,800	4,800	6,900	6,300	6,000	5,800									
90'	7,500	7,000	5,700	5,600	4,700	4,700	6,900	5,700	5,800	5,500									
95'	7,000	6,900	5,500	5,400	4,600	4,500	6,500	5,300	5,600	5,200									
100'	6,500	6,700	5,300	5,200	4,500	4,400	6,000	4,800	5,400	4,900									
105'	6,000	6,400	5,100	5,000	4,400	4,300	5,500	4,400	5,200	4,700									
110'	5,600	6,100	4,900	4,900	4,300	4,200	5,000	4,100	5,000	4,300									
115'	5,100	5,800	4,800	4,700	4,200	4,200	4,600	3,700	4,900	4,000									
120'	4,800	5,400	4,700	4,600	4,100	4,100	4,200	3,500	4,500	3,700									
125'	4,200	5,200	4,500	4,500	4,100	4,100	3,900	3,200	4,200	3,400									
130'	3,700	4,900	4,300	4,300	4,100	4,000	3,600	2,900	3,800	3,100									
135'	3,300	4,700	3,800	4,300			3,200	2,700	3,500	2,800									
140'	2,900	4,300	3,300	4,200			2,800	2,400	3,200	2,600									
145'	2,500	3,900	2,900	4,100			2,400	2,200	3,000	2,400									
150'	2,100	3,600	2,400	3,800			2,100	2,100	2,500	2,200									
155'	1,800	3,300					1,800	1,900	2,100	2,000									
160'		3,000					1,500	1,700	1,800	1,800									

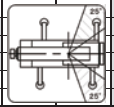

Telescoping conditions

Telescoping mode	1	2	1	2	1	2	1	2	1	2	1	2	1	2	1	2	1	2	1,2
------------------	---	---	---	---	---	---	---	---	---	---	---	---	---	---	---	---	---	---	-----

WARNING AND OPERATING INSTRUCTIONS

NOTES FOR LIFTING CAPACITIES

GENERAL

1. RATED LIFTING CAPACITIES apply only to the machine as originally manufactured and normally equipped by Tadano Ltd. Modifications to the machine or use of optional equipment other than that specified can result in a reduction of capacity.
2. Hydraulic cranes can be hazardous if improperly operated or maintained. Operation and maintenance of this machine must be in compliance with information, in the Operation and Maintenance Manual supported with the crane. If this manual is missing, order a replacement through the distributor.
3. The operator and other personnel associated with this machine shall fully acquaint themselves with the latest American National Standards Institute (ANSI) safety standards for cranes.

SET UP

1. Rated lifting capacities on the chart are the maximum allowable crane capacities and are based on the machine standing level on firm supporting surface under ideal job conditions. Depending on the nature of the supporting surface, it may be necessary to have structural supports under the outrigger floats to spread the loads to a larger bearing surface.
2. For outrigger operation, outriggers shall be properly extended with tires free of supporting surface before operating crane.

OPERATION

1. Rated lifting capacities have been tested to and meet minimum requirements of SAE J1063-cantilevered Boom Crane Structures Method of Test.
2. Rated lifting capacities do not exceed 85% of the tipping load on outriggers fully extended as determined by SAE J765-Crane Stability Test Code. Rated lifting capacities for partially extended outriggers are determined from the formula, Rated Lifting Capacities = (Tipping Load-0.1 x Tip Reaction) / 1.25.
3. Rated lifting capacities are based on actual load radius increased by boom deflection.
4. The weight of handling device such as hook blocks, slings, etc., must be considered as part of the load and must be deducted from the lifting capacities.
5. Rated lifting capacities are based on freely suspended loads and make no allowance for such factors as the effect of wind, sudden stopping of loads, supporting surface conditions, operating speeds, side loads, etc. Side pull on boom or jib is extremely dangerous. Such action can damage the boom, jib or slewing mechanism, and lead to overturning of the crane.
6. Rated lifting capacities do not account for wind on lifted load or boom. We recommend against working under the condition that the load is out of control due to a strong wind. During boom lift, consider that the rated lifting capacity is reduced by 50% when the wind speed is 20 mph (9 m/s) to 27 mph (12 m/s) ; reduced by 70% when the wind speed is 27 mph (12 m/s) to 31 mph (14 m/s). If the wind speed is 31 mph (14 m/s) or over, stop operation. During jib lift, stop operation if the wind speed is 20 mph (9 m/s) or over.
7. Rated lifting capacities at load radius shall not be exceeded. Do not tip the crane to determine allowable loads.
8. Do not operate at boom lengths, radii, or boom angle, where no capacities are shown. Crane may overturn without any load on the hook.
9. When boom length is between values listed, refer to the rated lifting capacities of the next longer and next shorter booms for the same radius. The lesser of the two rated lifting capacities shall be used.
10. When making lifts at a load radius not shown, use the next longer radius to determine allowable capacity.
11. Load per line should not exceed 15,900 lbs. (7,200 kg) for main winch and auxiliary winch.
12. Check the actual number of parts of line with LOAD MOMENT INDICATOR (AML-E2) before operation. Maximum lifting capacity is restricted by the number of parts of line of LOAD MOMENT INDICATOR (AML-E2). Limited capacity is as determined from the formula, Single line pull for main winch 15,900 lbs. (7,200 kg) x number of parts of line.

13. The boom angle before loading should be greater to account for deflection. For rated lifting capacities, the loaded boom angle and the load radius is for reference only. The 41.0' (12.5 m) boom length capacities are based on boom fully retracted.
14. The maximum capacity without boom pin (B-pin) is shown in the rated lifting capacity table.
15. The ability to telescope loads is limited by hydraulic pressure, boom angle, boom length, crane maintenance, etc.
16. For lifting capacity of single top, deduct the weight of the load handling equipment from the rated lifting capacity of the boom. For the lifting capacity of single top, the net capacity shall not exceed 15,900 lbs. (7,200 kg) including the main boom hook mass attached to the boom.
17. When the base jib or top jib or both jibs are dismantled, set the jib state switch to the DISMOUNTED position.
18. When erecting and stowing jib, be sure to retain it by hand or by other means to prevent its free movement.
19. Use "ANTI-TWOBLOCK" disable switch when erecting and stowing jib and when stowing hook block. While the switch is pushed, the hoist does not stop, even when overwind condition occurs.
20. When lifting a load by using jib (aux.winch) and boom (main winch) simultaneously, do the following:
 - Enter the operation status as jib operation, not as boom operation.
 - Before starting operation, make sure that mass of load is within rated lifting capacity for jib.
21. Outriggers shall be extended 23'7-1/2" (7.2 m) spread when mounting or dismantling removable counterweight.

DEFINITIONS

1. Load Radius: Horizontal distance from a projection of the axis of rotation to supporting surface before loading to the center of the vertical hoist line or tackle with load applied.
2. Loaded Boom Angle: The angle between the boom base section and the horizontal, after lifting the rated lifting capacity at the load radius.
3. Working Area: Area measured in a circular arc about the centerline of rotation.
4. Freely Suspended Load: Load hanging free with no direct external force applied except by the hoist line.
5. Side Load: Horizontal side force applied to the lifted load either on the ground or in the air.

WARNING AND OPERATING INSTRUCTIONS

NOTES FOR LOAD MOMENT INDICATOR (AML-E2)

1. Set AML select keys in accordance with the actually operating crane conditions and don't fail to make sure, before crane operation, that the displays on front panel are correct.
2. When operating crane:
 - Set starter switch to "ON"
 - Press the outrigger state select key to register for the outrigger operation. If the display agrees with the actual state, press the set key to register. After the completion of the registration, the display returns to the crane operation status.
 - Press the counterweight state select key to register for the counterweight state. If the display agrees with the actual state, press the set key to register. After the completion of the registration, the display returns to the crane operation status.
 - Press the lift state select key to register the lift state to be used (single top/jib/boom).
 - Each time the lift state select key is pressed, the display changes. If the display agrees with the actual state, press the set key to register. After the completion of the registration, the display returns to the crane operation status.
 - When erecting and stowing jib, select the status of jib set (Jib state indicative symbol lights up).
3. This machine is equipped with an automatic slewing stopping device. (For the details, see Operation and Maintenance Manual.) But, operate very carefully because the automatic slewing stop does not work in the following cases.
 - When the "AML OVERRIDE" switch is set to "ON" and the "Override key switch" outside the cab is "ON".
4. During crane operation, make sure that the displays on front panel are in accordance with actual operating conditions. The displayed values of LOAD MOMENT INDICATOR (AML-E2) are based on freely suspended loads and make no allowance for such factors as the effect of wind, sudden stopping of loads, supporting surface conditions, operating speed, side loads, etc.
5. For safe operation, it is recommended when extending and lowering boom or slewing, lifting loads shall be appropriately reduced.
6. LOAD MOMENT INDICATOR (AML-E2) is intended as an aid to the operator. Under no condition should it be relied upon to replace use of capacity charts and operating instruction. Sole reliance upon LOAD MOMENT INDICATOR (AML-E2) aids in place of good operating practice can cause an accident. The operator must exercise caution to assure safety.
7. The lifting capacity differs depending on the outrigger extension width and slewing position. Work with the capacity corresponding to the outrigger extension width and slewing position. For the relationship among the outrigger extension width, slewing position and lifting capacities, refer to the working area charts.

GT-800XL-2 COUNTERWEIGHT

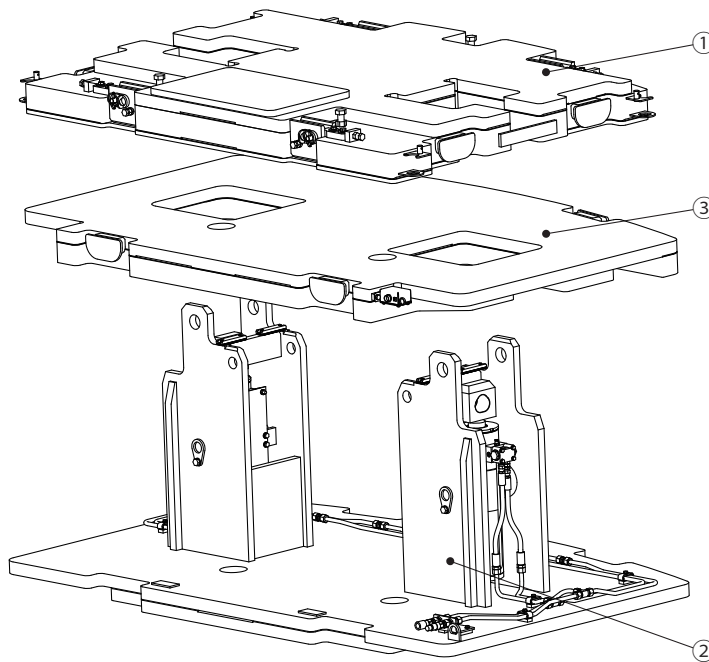

	0 lbs	6,700 lbs	12,400 lbs	17,900 lbs
① 6,700 lbs		1	1	1
② 5,700 lbs			1	1
③ 5,500 lbs				1

GT-800XL-2 AXLE WEIGHT DISTRIBUTION CHART

		lbs			kg		
		GVW	Front	Rear	GVW	Front	Rear
Base machine		87,450	41,850	45,600	39,660	18,985	20,675
Remove	7.9 t hook ball	-400	-650	250	-175	-300	125
	top and base jib	-2,550	-2,750	200	-1,160	-1,250	90
	single top	-100	-200	100	-55	-100	45
Add	7.9 t hook ball (stowed on the carrier)	400	450	-50	175	205	-30
	55 t hook block	1,450	2,500	-1,050	650	1,135	-485
	C/W 6,700 lbs on upper	6,700	-2,900	9,600	3,000	-1,325	4,325
	C/W 6,700 lbs on upper + 5,700 lbs on carrier deck	12,400	1,200	11,200	5,600	535	5,065
	C/W 6,700 lbs on upper + 11,200 lbs on carrier deck	17,900	5,150	12,750	8,100	2,320	5,780

		lbs			kg		
		GVW	Front	Rear	GVW	Front	Rear
Base machine		87,450	41,850	45,600	39,660	18,985	20,675
Add: C/W 6,700 lbs on upper 55 t hook block 7.9 t hook ball (stowed on carrier deck) Remove: 7.9 t hook ball		95,600	41,250	54,350	43,305	18,695	24,610
Add: C/W 6,700 lbs on upper + 5,700 lbs on carrier deck 55 t hook block 7.9 t hook ball (stowed on carrier deck) Remove: 7.9 t hook ball		101,300	45,350	55,950	45,905	20,555	25,350
Add: C/W 6,700 lbs on upper + 11,200 lbs on carrier deck 55 t hook block 7.9 t hook ball (stowed on carrier deck) Remove: 7.9 t hook ball		106,800	49,300	57,500	48,405	22,340	26,065
Permissible axle load		110,250	51,150	59,100	50,000	23,200	26,800

AXLE WEIGHT DISTRIBUTION EQUIPPED WITH DOLLY

	lbs				kg			
	GVW	Front	Rear	Dolly	GVW	Front	Rear	Dolly
Base machine without 7.9 t hook *Dolly weight is not included	87,050	33,700	38,500	14,850	39,485	15,280	17,455	6,750

Tadano Ltd.

KANDA SQUARE 18th Floor,
2-2-1 Kanda-Nishikicho,
Chiyoda-ku, Tokyo 101-0054, Japan
PHONE: +81-3-6811-7309
www.tadano.com

Tadano America Corporation

4242 West Greens Road.
Houston, Texas, 77066 U.S.A.
PHONE: (281) 869-0030
FAX: (281) 869-0040
www.tadanoamerica.com